

Control

EBC10v2

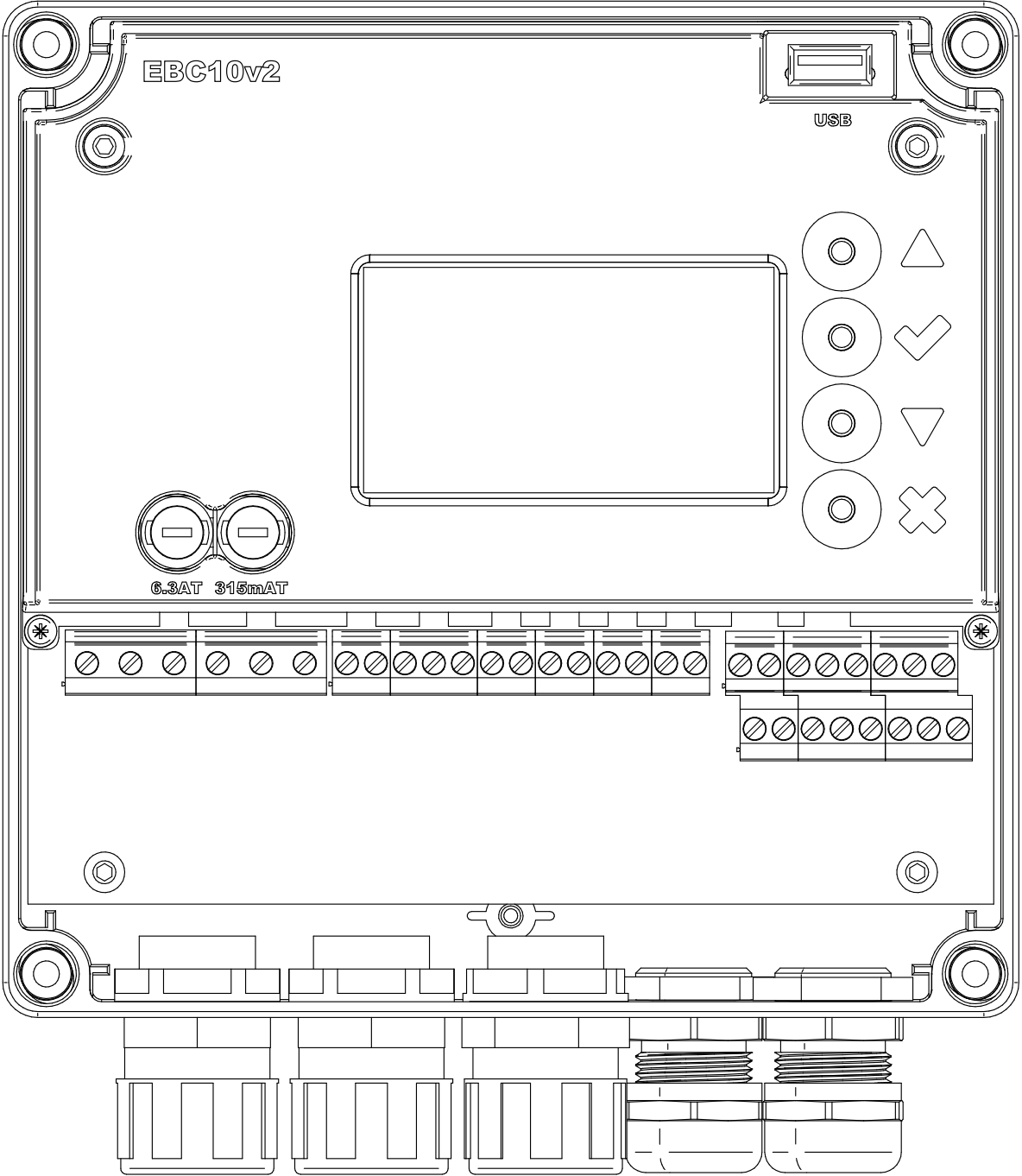

UK | Read and save these instructions!



Control | EBC10v2

Content

Product information	7
Scope of supply	7
Accessories and spare parts	7
Warranty	8
Technical specifications	9
Construction and components	10
Connection diagram	12
Outdoor fitting of the pressure transducer (XTP)	13
Layout of the user interface	14
Terminal board	15
Mechanical installation	17
Display	18
Introduction to the user interface	20
Setup - Chimney draft setting	21
Pre/post-purge	22
Temperature Sensor	23
Quick menu for setpoint	23
Settings and troubleshooting	24
Error codes	24
Overview of the service menu	25
Light-emitting diodes and terminal board	27
Basic functions of pressure control and supply air	28
Pressure-controlled regulation of the chimney fan	30
Area of use	30
Method of operation	30
One boiler application	31
Continuous operation	32
One boiler with potential free contact	33
One boiler and extra monitoring with PDS	34
One boiler with potential free contact and temperature sensor input	35
Pressure regulation of Exodraft supply air fan	36
General Use	36
Positioning	36
Method of operation	36
Electrical connection	36
Sample wiring diagram	36
UK Conformity Assessed	37
Declaration of Conformity	38



How to use this manual

This manual has been prepared based on the specific product and contains relevant technical information and installations guides.

Accessories and spare parts are not covered by this manual. Please refer to the individual manuals of these components.

This installation manual does not contain any system design documentation.

Failure to observe instructions marked with a danger symbol may result in personal injury and/or damage to the product.

Errors and omissions excepted.



Disposal

Electrical and electronic equipment (EEE) often contain materials, components and substances that may harm the environment or be hazardous to your health. Products (WEEE) marked with the 'crossed-out wheeled bin' symbol should be disposed of separately from other waste at the end of its life. Though legislation may differ from country to country we strongly advise that electrical and electronic waste is separated from other waste and disposed of according to national legislation to protect the environment and personnel that may come into contact with waste.

Symbols

The following symbols may be used in the manual to draw attention to danger or risk of personal injury or damage to the product.



General prohibition

Failure to observe instructions marked with the prohibited symbol may result in extreme danger or serious personal injury.



General attention

Marks a dangerous situation that, in the worst-case scenario, can cause serious personal injury or significant damage to the product.



General warning

Failure to observe instructions marked with a danger symbol may result in personal injury and/or damage to the product.



Electricity hazard/High Voltage

Marks a situation in which caution is advised due to the risk of high voltage electric shock which can cause serious personal injury or significant damage to the product.



Connect an earth terminal to the ground

Failure to observe instructions marked with a danger symbol may result in personal injury and/or damage to the product.



Permitted and approved

Permitted and approved method of installation.



Prohibited and not approved

Prohibited and not approved method of installation.



Warning

To minimise the risk of fire, electric shock, personal injury and/or damage to the product please observe the following:

- Please always read the manual and only use the product in accordance with the manufacturer's instructions. If in doubt, contact one of the Exodraft specialized dealers.
- All installations must be carried out by properly qualified personnel in accordance with national legislation and regulations.
- This product must be earthed. Get assistance from an qualified electrician when in doubt.
- This product must always be disconnected under the installation.
- Prior to servicing the product, disconnect the power and ensure that it cannot accidentally be reconnected.
- Exodraft always recommends the use of a smoke alarm when a solid fuel open fire is installed.
- If the Exodraft fan system has been designed for solid fuel/multi fuel installations, please ensure that the design meets the requirements of BS EN15287-1. If this cannot be achieved, a smoke alarm must be installed in the same room as the heat appliance.

Product information

The EBC10v2 (Exodraft Boiler Control) is a specially developed control component for constant pressure regulation of chimney draft. EBC10v2 is suitable for indoor installation.

By changing the setup, EBC10v2 can also regulate the supply of fresh air to the boiler room.

Incorrect use may result in problems with soot, chimney fires, etc. which might damage the product. Please check out this site for advice about the product:

www.exodraft.com

Scope of supply

- Exodraft EBC210v2
- XTP Sensor (Pressure transducer)
- Measuring probe for EBC10v2
- 2 metre silicone hose
- Installation manual and user instructions

Accessories and spare parts

The table below shows the accessories and spare parts available for the EBC10v2.

Accessories*
Relay Box
Frequency Inverter (FRK)
Silicone hose
External PDS

*This manual does not describe the specific use of accessories. We refer to the separate manuals for such components. For more details contact your Exodraft dealer.

Warranty

All Exodraft products are covered by a 2-year guarantee as per European consumer rights legislation. For some countries an extended period of guarantee may apply depending on either national legislation or other clearly stipulated conditions. Customer complaints must be handled by a specialised dealer or wholesaler (preferably where the Exodraft product has been bought originally). An updated list of Exodraft specialised dealers can be found on our website for the country in question.

Exodraft products must always be installed by properly qualified personnel. Exodraft reserves the right to change these guidelines without prior notice.

The warranty and liability does not cover instances regarding personal injury or damage to property or the product that can be ascribed to one or more of the following causes:

- Failure to follow this installation and operation manual
- Incorrect installation, start-up, maintenance or servicing
- Improper repairs
- Unauthorised structural modifications made to the product
- Installation of additional components that have not been tested/approved with the product
- Any damage resulting from continued use of the product despite an evident defect
- Failure to use original spareparts and accessories
- Failure to use the product as intended
- Exceeding or failure to meet the limit values in the technical data
- Force majeure

Technical specifications

The Exodraft EBC10v2 is a true PID-based fan speed control used to maintain a constant pressure or draught in a flue/duct system. It can only be used with Exodraft fans. The control automatically adjusts the speed based on the amount of exhaust gasses in the flue. EBC10v2 can control the fan speed on a single phase AC motor directly (1x230V) or a threephase motor indirectly via a VFD (variable frequency drive) that adjusts the motor speed.

The control has an integrated safety system to assure that heating appliances connected to the flue system will be shut down in case of insufficient draught. This ensures safe operation at all times, regardless of external factors (e.g. weather conditions).

Technical data

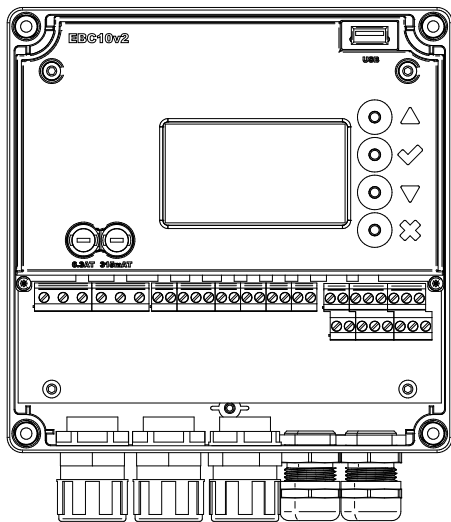

Data	EBC10v2
H x W x D [mm]	175 x 175 x 100
Weight	1.5 kg
IP-rating / material	IP 54
Fuse	4.0T A
Power supply	1x 230 V / 50 Hz
Max. motor load	0.35 kW / 0.5 hp
Operating temperature	-20 to 50 °C
Selection of operations	0-150 Pa

Data	EBC10v2
Tolerance	+/-5%v Pa
+24V supply	100 mA Max
Control and alarm relay	230 VAC/4A AC1 - 24 VDC/2A DC1 Max
Boiler inputs	10-48 VDC / 10-230 VAC
VFD Relay	230 VAC/2A AC1 - 24VDC/2A DC1 Max
Output TRIAC	10-230 VAC
Temperature Input	Pt1000

Construction and components

1	EBC10v2 (EBC10v2EU01)
2	XTP150 G - Pressure transducer
3	Measuring probe
4	Silicone hose

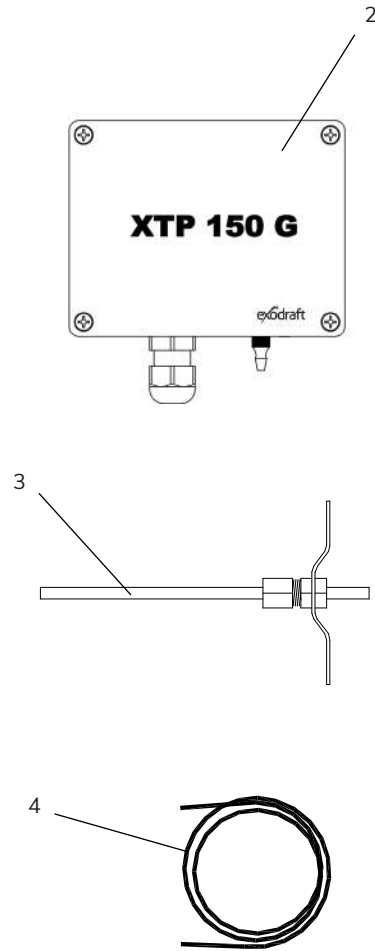
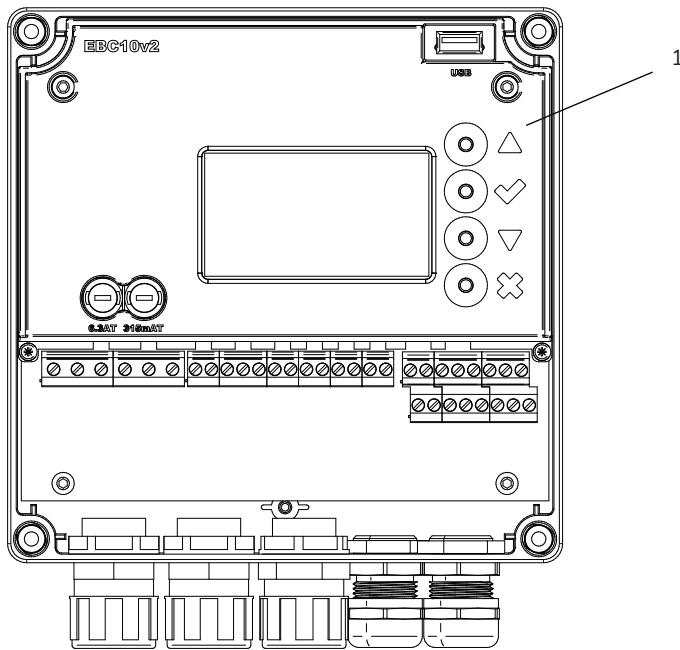

Data	XTP Sensor
H x W x D [mm]	80 x 82 x 55.5
Power supply	24 VDC(+/- 15%)
IP-Rating	IP 54
Output	0-10 VDC, max 10 mA
Operating temperature	-25 to 50 °C
Tolerance	+/-5% Pa

Data	Chimney Probe
H x l [mm]	108 x 89

Components function

Item no.	Part	Function
EBC10v2EU01	EBC10v2	Controls Exodraft fans and chimney fans. For indoor installations.
XTP150G	Pressure transducer (XTP)	Measures difference air pressure in the boiler room or chimney, or outdoor atmospheric pressure.
3200814	Measuring probe for EBC10v2EU01	Measures pressure in the chimney. (EBC10v2EU01)
2000335	2 m silicone hose	Supplies the pressure transducer (XTP) with reference pressure from the measuring probe or from outdoors.
1100755	Temperature sensor	Measures the temperature
REP-AFB	Rep. switch	Isolation switch
ES12	Relay Box	If more than 2 boilers are connected

Fitting

Max. cable length between EBC10v2 and XTP are 100 m.

Max. cable length between EBC10v2 and chimney fan / fan are 100 m.

Max. cable length between XTP and measuring probe are 2 m.

Connection diagram

The EBC10v2 is to be fitted and connected as shown in the diagram below.

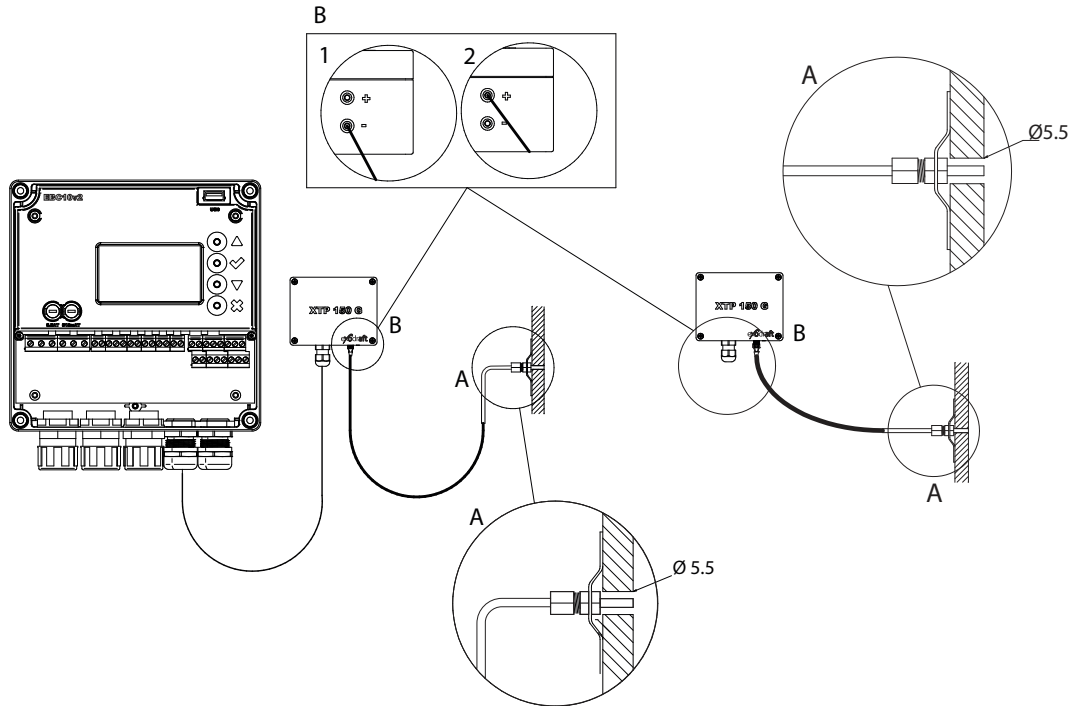

Control of	Fitting procedure
Chimney fan	<ul style="list-style-type: none"> Install EBC10v2EU01 and the pressure transducer (XTP) in the boiler room. Fit the measuring probe (A) in the boiler flue or in the manifold. However, for atmospheric boilers, the probe must always be positioned after the draft hood. Connect the hose from the measuring probe to the negative terminal on the pressure transducer "B1".
Note!	<ul style="list-style-type: none"> When the measuring probe is placed outside, it must be installed in a manner that prevents the formation of condensation or ice. EBC10v2EU01 comes with a straight measuring probe. EBC10v2 must always be installed where it is protected from wind and weather (rain, snow, etc.)
Supply air fan	<ul style="list-style-type: none"> Install the control and the pressure transducer (XTP) in the boiler room. Connect the hose for measuring reference pressure (outdoor atmospheric pressure) to the negative terminal "B1" on the pressure transducer. Run the hose outside the building to a place not exposed to the weather. The open end of the hose may be installed inside a box as described at the top of the next page.
Note!	<ul style="list-style-type: none"> Particularly when wanting positive pressure* in the chimney / boiler room: Connect the hose to the positive terminal on the pressure transducer "B2". EBC10v2 comes with only 2 m of hose.



*The default setting of the EBC10v2 is for negative pressure regulation, but local authority requirements may state that positive pressure must be maintained.



The pressure transducer cannot be mounted inside an air tight enclosure. It uses the atmospheric pressure as reference pressure.

Outdoor fitting of the pressure transducer (XTP)

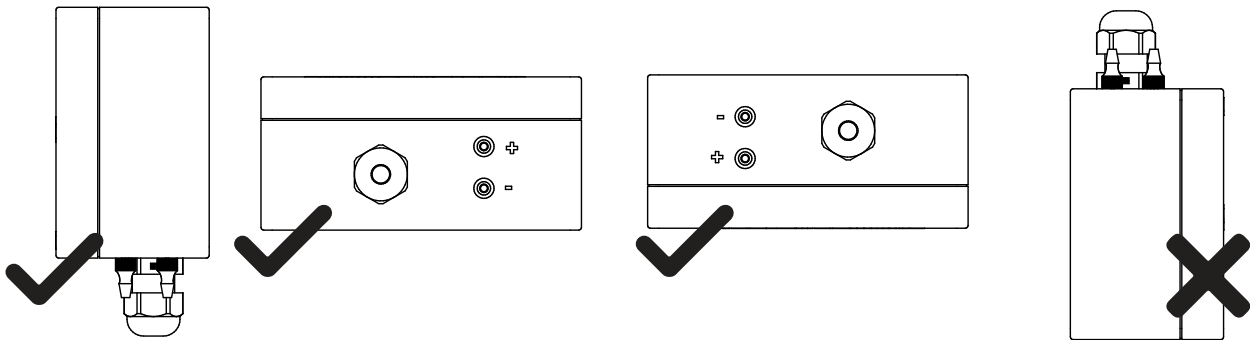

If there is a risk of adverse effect from strong winds, the hose (A) located inside the XTP 150G can be removed from the (+) valve.

For outdoor installation, place the pressure transducer where it is not exposed to the weather. For outdoor installation, the pressure transducer should be placed in a box fitted with a hole ($\varnothing 2\text{mm}$) in the bottom. The hole serves to ensure correct reference pressure and prevent water entry

If the pressure transducer is positioned in a place where insects have access to the free end, fitting a sinter filter is recommended.







Make sure to position the pressure transducer the right way up.

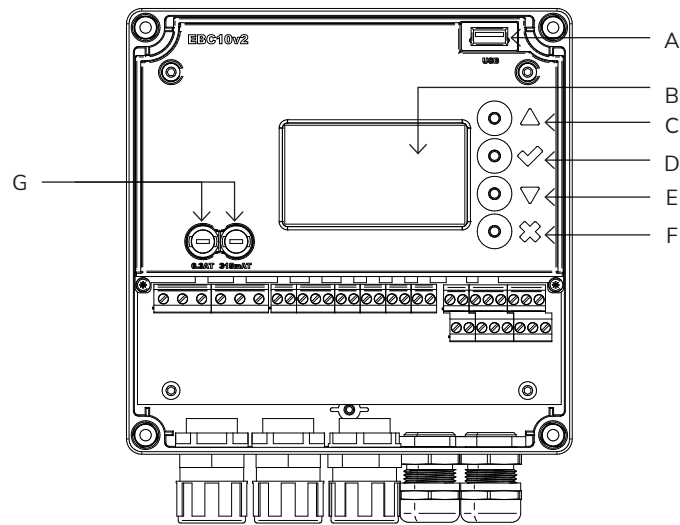

Do not blow into the valves on the XTP 150 G

Layout of the user interface



Pos.	Part	Function
A	USB	USB interface
B	Display	Displays operation and changes in the user interface (menu system) Indicates alarms Shows normal operation status
C		Forward / up in the menu system Increase set point
D		Approves your action Forward
E		Go down in the menu system Reduce set point
F		Interrupt action Back
G	Fuse	Fuse type

Terminal board

The chart below lists the connection options for the terminal boards.

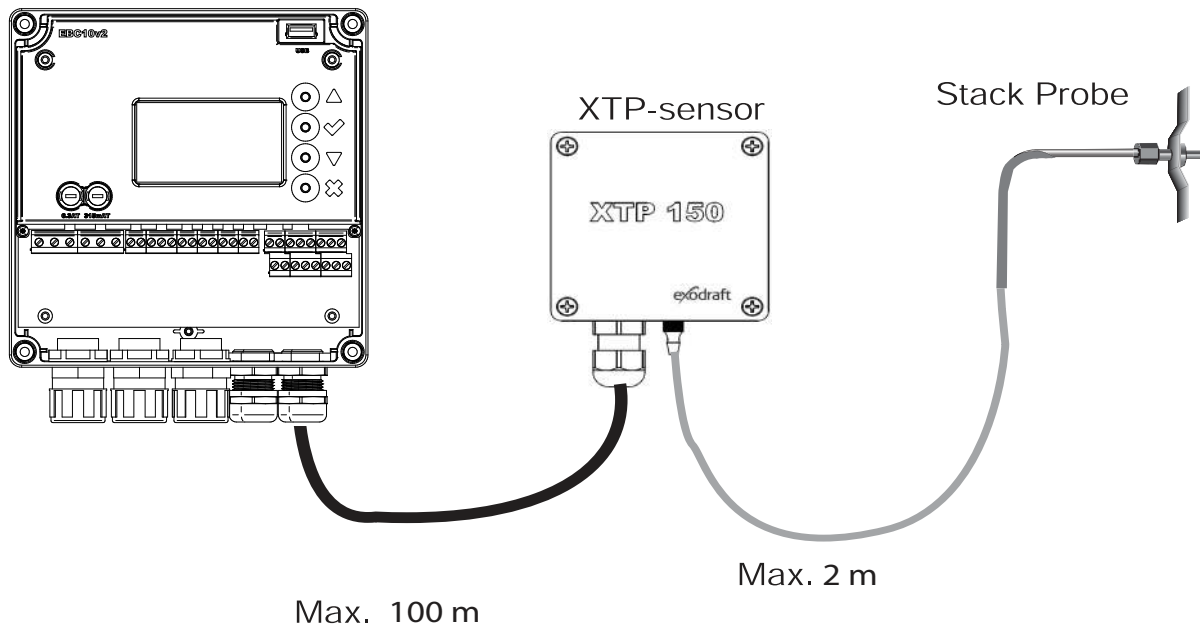

Do not install the transducer in an airtight enclosure. It uses the boiler room pressure / atmospheric pressure as reference pressure.

The control can be installed directly on the wall or somewhere similar.

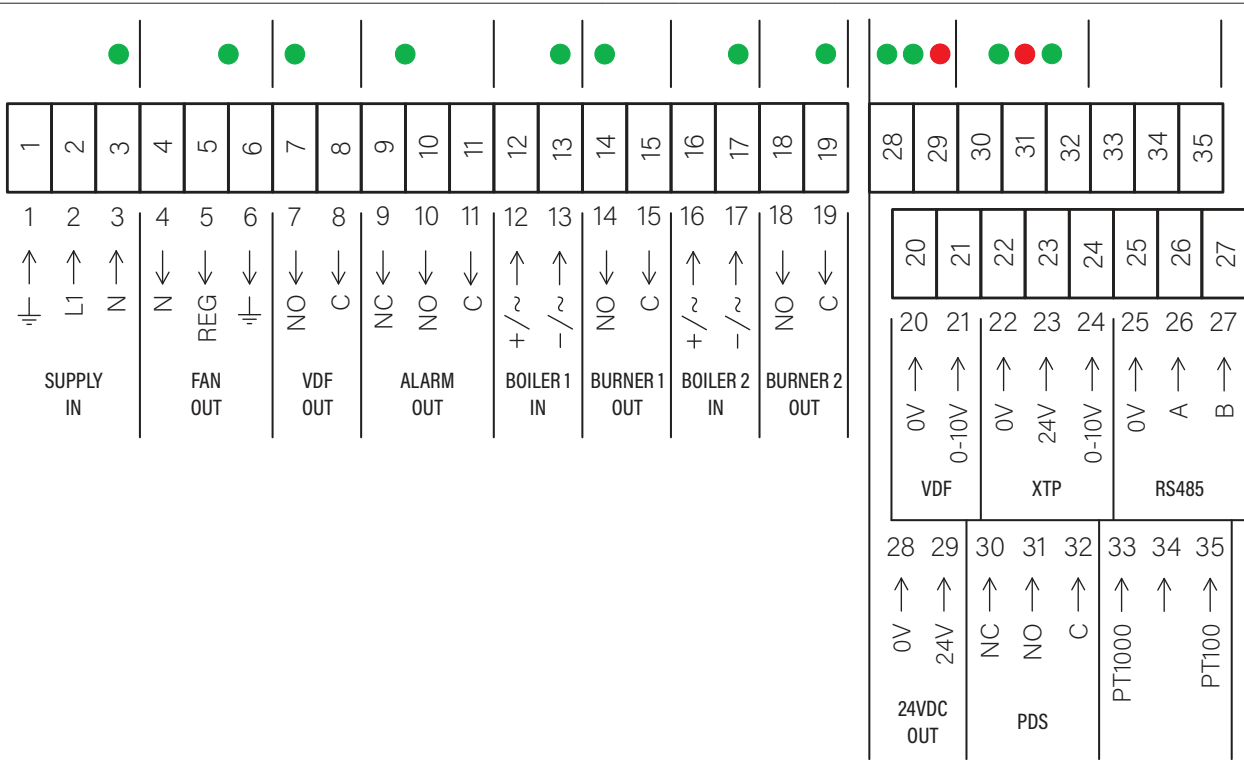

Terminal	Use
1	PE Ground
2	Supply - L1
3	Supply - N
4	Chimney fan - N
5	Chimney fan - L1 (Regulating)
6	Chimney fan - PE Ground
7	Inactive
8	Inactive
9	Alarm Out - NC
10	Alarm Out - NO
11	Alarm Out - C
12	Voltage input from appliance / boiler 1 thermostat optocoupler (+) (10-230V AC/DC)
13	Voltage input from appliance / boiler 1 thermostat optocoupler (-) (10-230V AC/DC)
14	Burner 1 relay switch-Normally open (max. 230 VAC, 2 amps.)
15	Burner 1 relay switch-Common (max. 230 VAC, 2 amps.)
16	Inactive
17	Inactive

Terminal	Use
18	Inactive
19	Inactive
20	Inactive
21	Inactive
22	XTP-0V DC power supply (transducer)
23	XTP-24V DC power supply (transducer)
24	XTP-0-10V DC signal (transducer)
25	Inactive
26	Inactive
27	Inactive
28	0V DC power supply
29	24V DC power supply (Max. 100 mA)
30	PDS-NC (normally closed) Proven draft switch
31	PDS-NO (normally open) Proven draft switch
32	PDS-C (shared) Tested draft switch
33	Pt1000
34	Not used
35	Pt1000

*However, terminals 30, 31, and 32 may be used for connecting other auxiliary monitoring equipment as well.

Mechanical installation

The control and the transducer must be installed inside, preferably in the boiler room.
The control does not need to be installed in a cabinet.

- Take off the lid.
- The installation holes are placed under the plastic screws keeping the cover in place.
- The distance between the control and the transducer should not exceed 100 m.

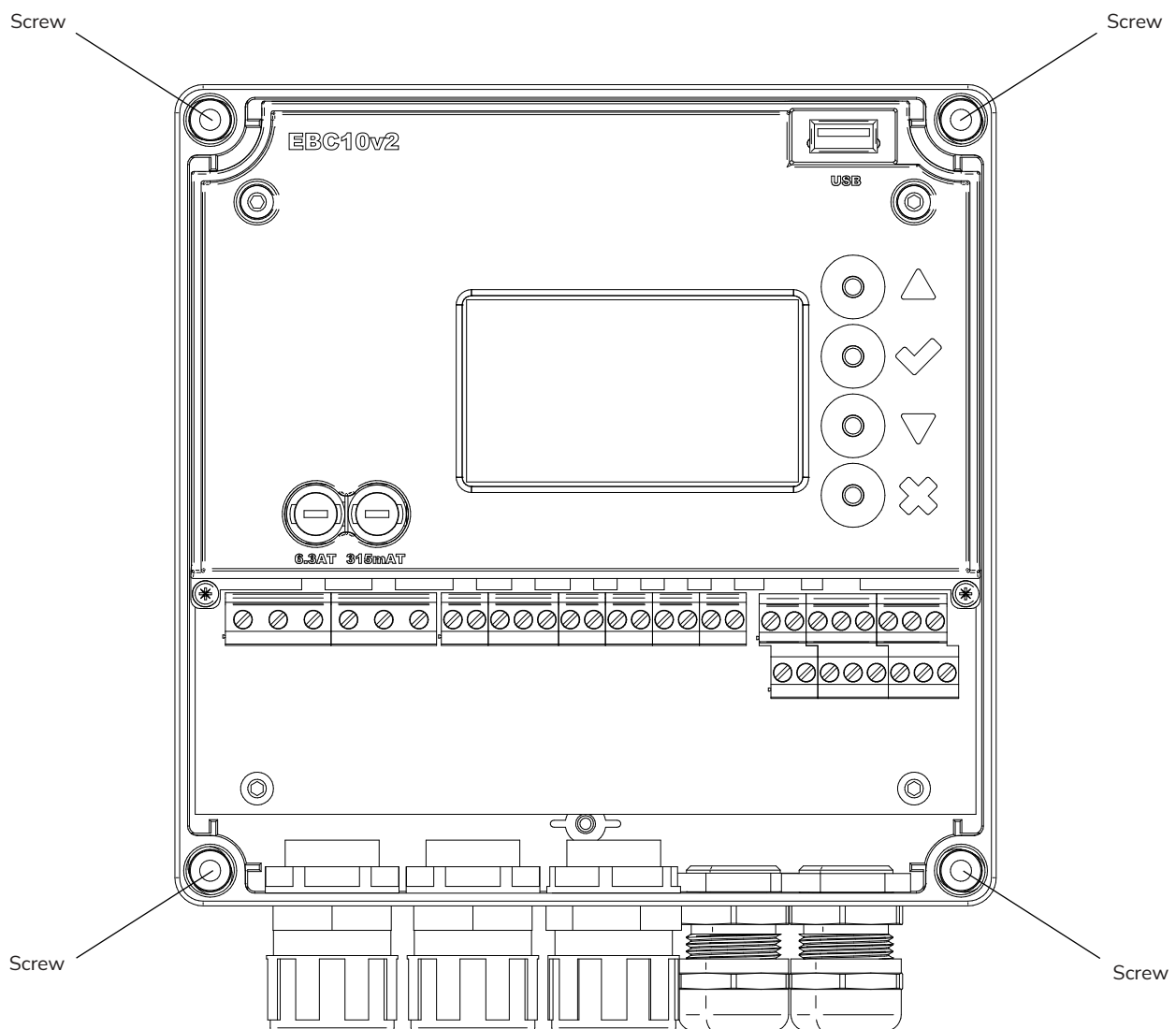

Display

The diagram below shows the layout of the display on the EBC10v2. All possible display values are indicated:



Only qualified personnel should use the service menu

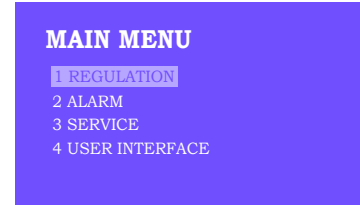
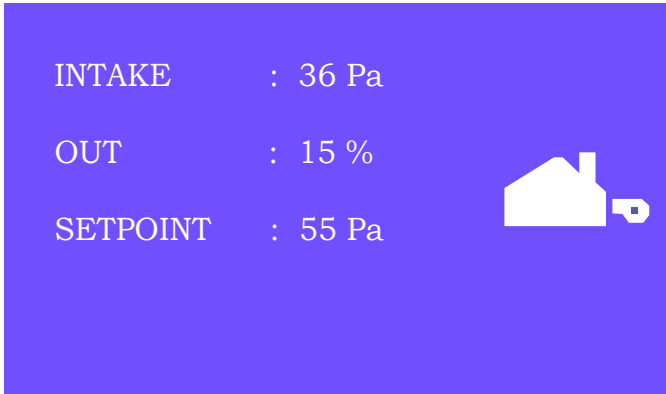



The purpose of the display is to indicate

- Operating information (pressure, etc.)
- Alarms
- Parameters
- Set points
- USB

Using the interface

The user interface is operated via four buttons with the following functions:

Button	Function
	Activate the service menu Edit and save settings
	Go to menu item and adjust value
	Return to operation screen from any point in the menu system Reset alarm when "Manual Reset" is selected in menu 2.3.

Setting the language

It is possible to change the language on the display. The default setting is in English.

To set the language on the screen, follow these steps.

Step	Action	Display
1	Go to the Main Menu (Enter check mark) Select 4. User Interface	
2	Select 1. Display	
3	Select 1. Language	
4	Use the arrow keys to switch between languages Finish the approval/storage via the check box The display should now have switched to the desired language	

Locked home screen

Access to the service menu is open as a default. It is possible to lock the home screen with a code.

To turn the code on/off, follow these steps.

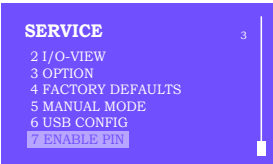
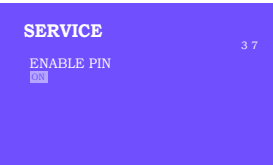
Step	Action	Display
1	Go to the Main Menu Select 3. Service	
2	Select 7. Enable Pin	
3	Use the arrow keys to toggle between off and on Approve/Save with check mark	

If you have selected the code to be enabled:

- Activate the service menu (keep the check button pressed for 5 seconds)
- Enter code 3142
- Set the value with the arrows and confirm on the way / finally with the check button







Introduction to the user interface

The service menu is built up in four levels:

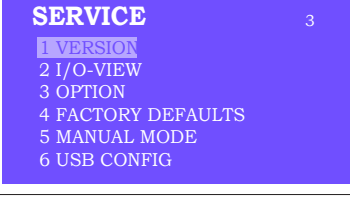

The service menu consists of four main menus, each divided into submenus.

1. Regulation
2. Alarms
3. Service
4. User interface

Menu	Function description	Display
1	1.1 Pressure regulation: 0-95%: 0-150 Pa 1.2 Operating mode: Continuous or Intermittent 1.3 Pre-purge: Time and speed mode 1.4 Post-purge: Time and speed mode 1.5 Sensor: Range min. and max. 1.6 Properties: See Service menu overview	 <p>REGULATION 1</p> <ul style="list-style-type: none"> 1 SET PRESSURE 2 OPERATION MODE 3 PRE-PURGE 4 POST-PURGE 5 SENSOR 6 PROPERTIES
2	2.1 Error: Alarm type 2.2 Error log: Alarm log covering 19 alarms 2.3 Reset: Automatic or manual	 <p>ALARM 2</p> <ul style="list-style-type: none"> 1 ERROR 2 ERROR LOG 3 RESET
3	3.1. Version no. 3.2 I/O-view: Input/output monitor/activator 3.3 Option: Bearing cycle, prime, draft input delay. 3.4 Factory presets: Default settings 5 Manual mode: TRIAC/frequency inverter output 0-100% 6 USB config: Updating of firmware, configuration files	 <p>SERVICE 3</p> <ul style="list-style-type: none"> 1 VERSION 2 I/O-VIEW 3 OPTION 4 FACTORY DEFAULTS 5 MANUAL MODE 6 USB CONFIG
4	4.1 Display: Language, units, and LCD settings	 <p>USER INTERFACE 4</p> <ul style="list-style-type: none"> 1 DISPLAY

Setup - Chimney draft setting

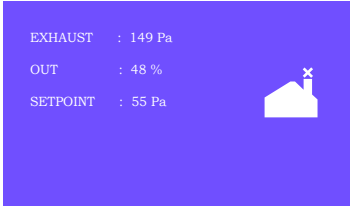
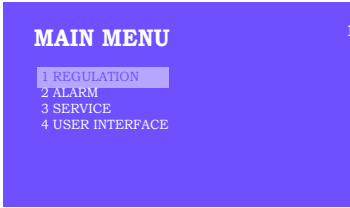
To set the pressure in the chimney, follow the procedure detailed below







Step	Action	Display
1	Start the system EBC10v2 displays the actual negative pressure (in this example, 55 Pa)	
2	Press and hold for 5 seconds to get into the service menu Enter code: 3142 Select menu 1	
3	Select menu 1.1	
4	Set required pressure	

Note! This procedure only covers setting the pressure in the chimney.

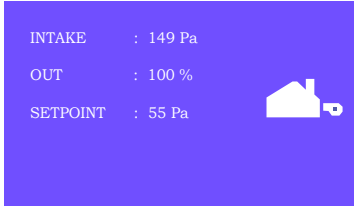
* Only if the controller is locked with a pin code

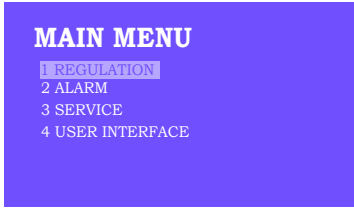
Pre/post-purge

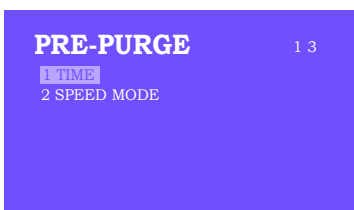
To set up pre-/post-purge period, follow procedure below:

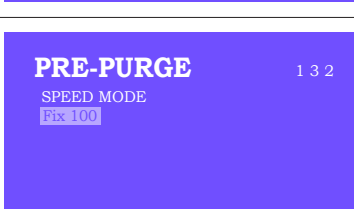
Step	Action	Display
1	Start the system EBC10v2 displays the actual negative pressure (in this example, 55 Pa)	
2*	Press and hold  for 5 seconds to get into the service menu Enter code: 3142 Select menu 1	
3	Regulation 1 Select menu 1.3 Pre-purge Select menu 1.4 Post-purge	
4	Select either 1.3.1 Time or 1.3.2 speed mode	
5	Set the desired time in seconds 0-1800 seconds	
6	Fix 20-100 or variable Finish and return to operation screen with	



* Only if the controller is locked with a pin code

Temperature Sensor

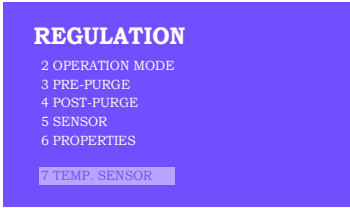
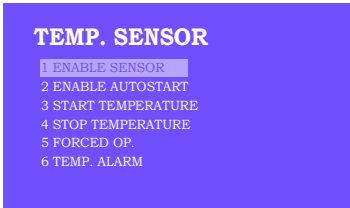
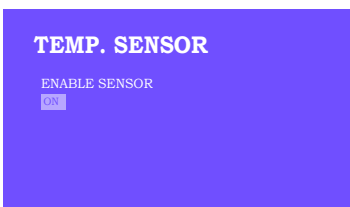
To activate the temperature sensor, follow the procedure below:

Step	Action	Display
1	Go to the Main Menu Select 1. Regulation	
2	Select 7. Temperature sensor	
3	Select 1. Enable Sensor	
4	Use the arrow keys to toggle between off and on Approve/Save with check mark	

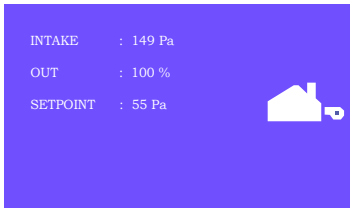
Quick menu for setpoint

Step	Action	Display
1	Start the system EBC10v2 displays the actual negative pressure (in this example, 55 Pa)	
2	Press  Use the arrow keys to switch between the set pressure Approve/Save with check mark	

Settings and troubleshooting

Error codes

Most terminal connections are monitored for correct operation. An LED light indicates operating status. If a light comes on, it is an indication that everything is functioning correctly, while a light going out indicates a problem in the circuit it monitors. In addition, error codes are shown on the display.

The error codes are

Display	Explanation
A1 Draft Exhaust	<p>Insufficient pressure may be due to:</p> <ol style="list-style-type: none"> 1. Chimney fan has insufficient capacity 2. Mechanical or electrical fan failure 3. Blocked chimney 4. Introduction of excessive dilution air 5. XTP sensor not responding correctly
A2 Power Fault	Indicates that there has been a power fault
A3 XTP-Exhaust	<p>Indicates a disconnected signal from the XTP sensor on the exhaust side to the control. May be caused by:</p> <ol style="list-style-type: none"> 1. Lose connections 2. Faulty XTP-sensor 3. Defective controller
A4 Error Start	Indicates that the control has been unable to release the burner within 15 minutes.
A5 Alarm Override	Indicates alarm has been disregarded
A6 Draft Input	Missing signal from PDS function. Indicates a defective function.
A7 RS485 error	No communication between EBC10v2 and modbus network
A8 Priority	The draft has been insufficient and therefore the control has been in priority

Overview of the service menu

The service menu is built in 4 levels and associated submenus.

Menu	Sub-menu	Function	Display	Description	Classification	Standard
1		Exhaust	EXHAUST			
	11	Draft set point	SET EXHAUST	Adjustment of exhaust setpoint.	2%-95% af sensor	17%
	12	Operation mode	EXHAUST MODE	Continuous or intermittent operation. In intermittent mode the exhaust fan runs only if one or more boiler inputs are active.	Continuous/ Intermittent	Intermittent
	13	Pre-purge	PRE-PURGE	Pre-purge settings.		
	131	Time	TIME	Pre-purge time in seconds	0-1800	0
	132	Operation mode	SPEED MODE	Select variable if the pre-purge should be controlled by the XTP-sensor or have a fixed speed.	Variable / FIX 20-100%	FIX 100%
	14	Post-purge	POST-PURGE	Post-purge settings.		
	141	Time	TIME	Post-purge time in seconds	0-1800	0
	142	Operation mode	SPEED MODE	Select variable if the post-purge should be controlled by the XTP-sensor or have a fixed speed.	Variable / FIX 20-100%	Variable
	15	Sensor	SENSOR			
	151	Min. pressure	RANGE MIN	XTP minimum pressure in Pa.	-500 – 500 Pa	0
	152	Max. pressure	RANGE MAX	XTP Maximum pressure in Pa.	0 – 1000 Pa	150 Pa
	16	Parameters	PROPERTIES			
	161	Alarm limit draft	ALARM LIMIT	Select the alarm limit of the draft. The value is in % of the set point.	If 167 = "Negative" ->50 - 80 % If 167 = "Positive" -> 150 - 300 %"	64 % (167 = "Negative") 144 % (167 = "Positive")
	162	Alarmdelay	ALARM DELAY	Select a alarm delay from 0-120 seconds.	0 – 120 s	15
	163	Min. voltage	SPEED MIN	Mimimum speed of the fan	0 – MENU 164	15 %
	164	Max. voltage	SPEED MAX	Maksimum speed of the fan.	MENU 163-100%	100
	165	Xp	EXHAUST Xp	Proportional gain.	0-30	15
	166	Ti	EXHAUST Ti	Integral gain.	0-30	8
	167	Sampling rate	SAMPLING RATE	Set the sampling rate for the PID Loop	1-10	10
	168	Pressure type	PRESSURE MODE	Positive or negative pressure in the stack.	Positive or Negative	Negative
	169	Application	APPLICATION	Sets if the control has to work as Exhaust or Intake	Exhaust / Intake	Exhaust
	17	Temperature Sensor	TEMP. SENSOR			
	171	Enable Sensor	ENABLE SENSOR	Enables the temperature sensor and displays the current temperature on the main screen	On/Off	Off
	172	Enable Autostart	ENABLE AUTOSTART	Enables the temperature as a start signal for the controller	On/Off	Off
	173	Start Temperature	START TEMPERATURE	Sets the start temperature	40-100° C	40° C
	174	Stop Temperature	STOP TEMPERATURE	Sets the stop temperature	0-Start Temperature - 5	35° C
	175	Forced operation	FORCED OP.			
	1751	Set Forced opera.	SET FORCED OP.	Enables the full speed operation of the chimney fan, if the forced operation temperature setpoint is reached	On/Off	Off
	1752	Temperature Limit	Temperature Limit	Sets the limit temperature	5-450° C	250° C
	176	Temperature Alarm	TEMP. ALARM			
	1761	Enable Temp. Alarm	ENABLE. TEMP. ALARM	Enables the alarm relay if the setpoint is reached	On/Off	Off
	1762	Alarm Limit	ALARM LIMIT	Sets the alarm limit	25-450° C	450° C
	1763	Alarm Delay	ALARM DELAY	Sets the delay before the alarm	0-60 Seconds	5
2		ALARM				
	21	Alarm Status	ERROR	The error is shown here		
	22	Alarm log	ERROR LOG	The last 10 alarms will be saved in the menu.		
	23	Reset	RESET	Selecting "AUTO" will automatic reset the alarm after 15 seconds. If "MAN" is selected, the "X" has to be pressed.	MAN / AUTO	AUTO

Menu	Sub-menu	Function	Display	Description	Classification	Standard
3		Service	SERVICE			
	31	Version no.	VERSION	Software version is showed.		
	32	I/O	I/O-VIEW			
	321	BURNER I/O	AUX OUT XXX AUX IN XX	In this menu the status of the boiler I/O is shown. By pressing at the AUX OUT relays can be activated by pressing up and down. Multiple activations of the a button will move from relay 1 to 6		
	322	EXHAUST I/O	EXH XTP x.xV OFF EXH VFD x.xV OFF	XTP, VFD and VFD relay status for Exhaust.		
	323	Draft input	DRAFT INPUT ON/ OFF	Draft Input I/O status.		
	324	Alarm relay	ALARM OUTPUT ON/ OFF	Alarm relay output status.		
33		Options	OPTION			
	331	Bearing cycle	BEARING CYCLE	Selecting "YES" will enable a bearing cycle on present fans, if the boilers has not been active for 24 hours.	ON/OFF	ON
	332	Allow prime		Selecting a number from 0-250 will enable the prime function. This allows the boilers to be activated even though no sufficient draft is present.	0-250 s / off	Off
	333	Draft Input Delay	DRAFT INPUT DELAY	The delay before the control goes into Fraft Alarm	0-20 s	0 s
34		Factory reset	FACTORY	If "YES" is selected, a factory reset will be performed.	YES/NO	NO
35		Manual Mode	MANUAL MODE	Set a specific value for a continuous chimney fan speed.	0-100%	0% i.e. disabled
36		USB configuration	USB CONFIG			
	361	format USB	FORMAT USB	Selecting "YES" will format the USB flash drive. Notice! All data will erased!	YES / NO	NO
	362	Data Log	DATA LOG USB / INTERNAL	Selecting "USB" will store the alarm log on the USB flash drive, "INT" will store the log in the internal memory.	USB / INT	INT
	363	Save config. file	SAVE CONFIG FILE	Selecting "YES" provides the possibility to select configurationfiles stored on the USB flash drive.	YES / NO	NO
	364	Load config. file	LOAD CONFIG FILE	Selecting "YES" will download the current configuration to the USB flash drive.	YES / NO	NO
	365	Upgrade firmware	UPGRADE FIRMWARE	This function provides the possibility to upgrade the firmware by means of a USB Stick		
4		User Interface	USER INTERFACE			
	41	Display	DISPLAY			
	411	Language	LANGUAGE	Language.	ENG/DEU/DNK/ SWE/NOR/FRA/ESP	ENG
	412	Pressure units	UNITS	Pa or inWC units.	Pa / inWC	inWC
	413	LCD backlight	LCD BACKLIGHT	LCD backlight turned on or not. The USE parameter will cause the backlight to be turned on if a button is pressed.	ON / OFF / USE	ON
	414	LCD contrast	LCD CONTRAST		10 – 100 %	50

Light-emitting diodes and terminal board

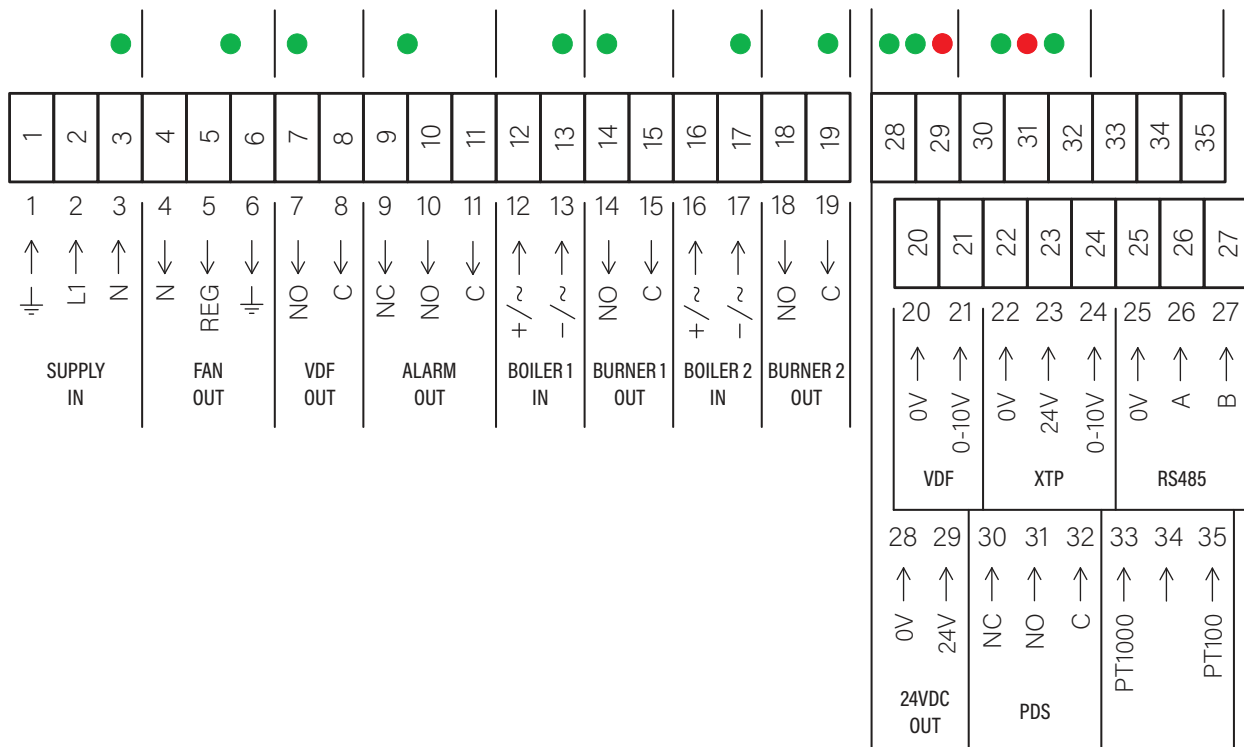

No.	Designation	Max. load	Meaning when the light-emitting diode is:
1, 2 and 3	SUPPLY IN	230-240 V AC +/- 10 %	Green: EBC10v2 is connected to power supply
4, 5 and 6	FAN OUT	3A	Green: the Triac output is active
7 and 8	VFD OUT	250 V AC, 8A, AC3	Green: the relay is closed
9, 10 and 11	ALARM OUT	250 V AC, 8A, AC3	Green: the relay is active
12 and 13	BOILER 1 IN	18 til 230 V DC/V AC	Green: the input is active
14 and 15	BURNER 1 OUT	250 V AC, 4A, AC3	Green: the relay is closed
16 and 17	Inactive		
18 and 19	Inactive		
28 and 29	24 V DC OUT	100 mA	Green: voltage is OK Red: overload
20 and 21	Inactive		
22, 23 and 24	XTP IN		Green: XTP connected Red: return voltage > 12 V DC
30, 31 and 32	PDS IN *		Green: C & NO are closed



*However, terminals 30, 31, and 32 may be used for connecting other auxiliary monitoring equipment as well.

Basic functions of pressure control and supply air

Default settings

EBC10v2 defaults to constant pressure regulation of Exodraft chimney fans (basic function 1 Exhaust/ Intake)

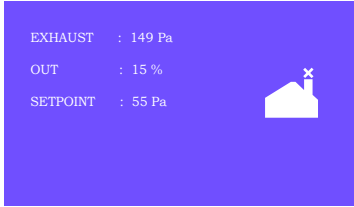
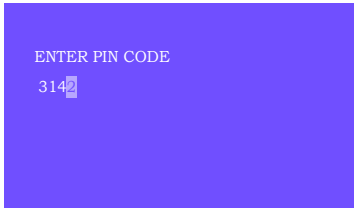
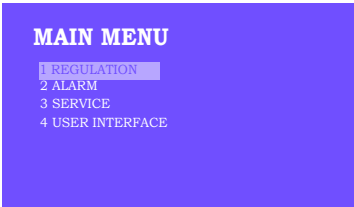
Change of basic function

Step	Action	Display
1	Press and hold ✓ for 5 seconds	
2*	Enter code: 3142 Use arrows to select followed by * Only if the controller is locked with a pin code	
3	Select menu 1 Regulation	
4	Select menu 1.6 Properties	

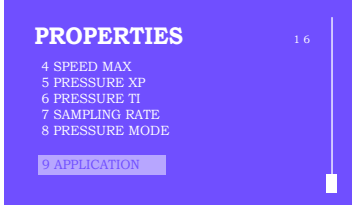
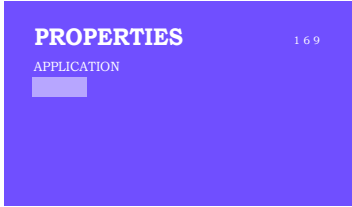
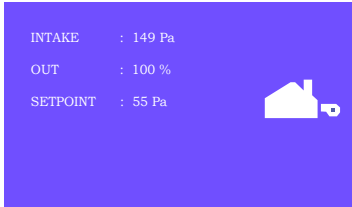
5	Select menu 1.6.9 application	 <p>PROPERTIES 1.6</p> <p>4 SPEED MAX 5 PRESSURE XP 6 PRESSURE TI 7 SAMPLING RATE 8 PRESSURE MODE</p> <p>9 APPLICATION</p>
6	<p>1. Pressure regulation of Exodraft chimney fans (Exhaust) 2. Pressure control of Supply air fan (Intake)</p>	 <p>PROPERTIES 1.6.9</p> <p>APPLICATION</p>
7	Finish and return to operation screen	 <p>INTAKE : 149 Pa OUT : 100 % SETPOINT : 55 Pa</p>



Exodraft recommends contacting the boiler manufacturer for correct connection to the boiler automation.

Pressure-controlled regulation of the chimney fan

Area of use

- The EBC10v2 can also be used for boiler systems with modulating burners.
- EBC10v2 can control a chimney fan directly.
- The control system is intended for:
 - Solid fuel boilers
 - Atmospheric gas boilers
 - Atmospheric gas boilers
 - Boilers with oil and gas blow torches

Method of operation

General function

- The control system monitors chimney draft and disconnects the burner in the event of errors (the alarmdiode on the EBC10v2 will turn on).
- When the boiler thermostat demands heat, the chimney fan will start at max. voltage.
- The EBC10v2 maintains the set pressure by regulating the voltage. The pressure is shown in the display.
- In the event of an insufficient pressure the burner will be disconnected after 15 seconds. "Insufficient pressure" is less than 64% of the set value, corresponding less than 80% flow.
- When the boiler switches off, the chimney fan is also stopped. However, it is possible to set a post-purge period for the chimney fan. Alternatively, the control system can be set up to keep the chimney fan running continuously.

Light emitting diodes and output signals

All inputs and outputs are linked to light emitting diodes for the monitoring and service of the system (Light emitting diodes and terminal board).

One boiler application

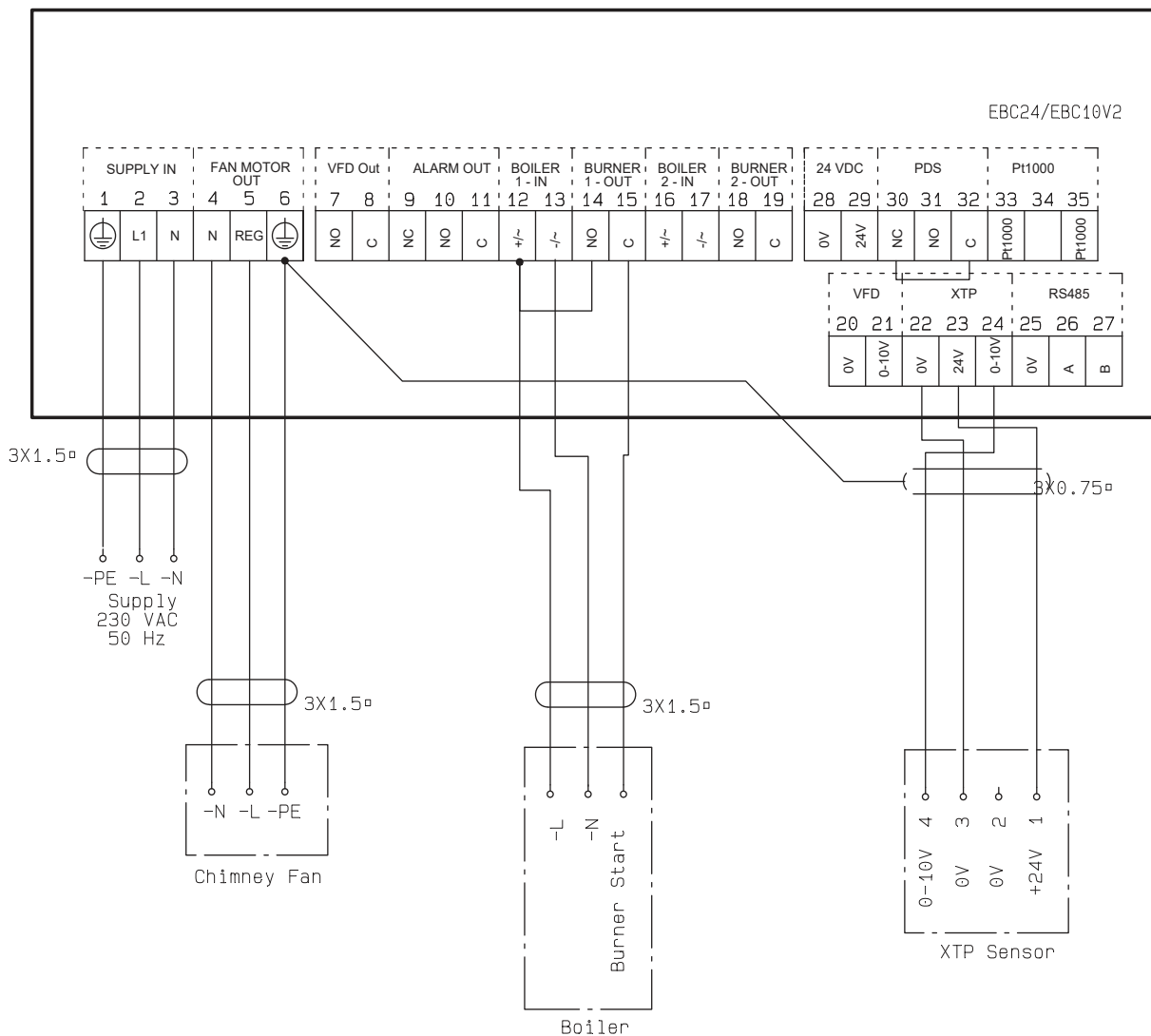

This example shows how to connect a voltage signal (18-230 V AC/DC) to EBC10v2 to start/stop the chimney fan

- Connect the supply to terminals 1-3.
- Connecting the boiler:
- Connect the burner start signal (L) to terminal 12.
- Connect the neutral wire to terminal 13.
- The start signal for the burner is sent from terminal 15.
- Loop terminals 12 and 14.
- Connect the chimney fan to terminals 4-6.
- Connect the pressure transducer (XTP) to terminals 22-24 with a shielded cable, and connect the display to terminal 6

Continuous operation

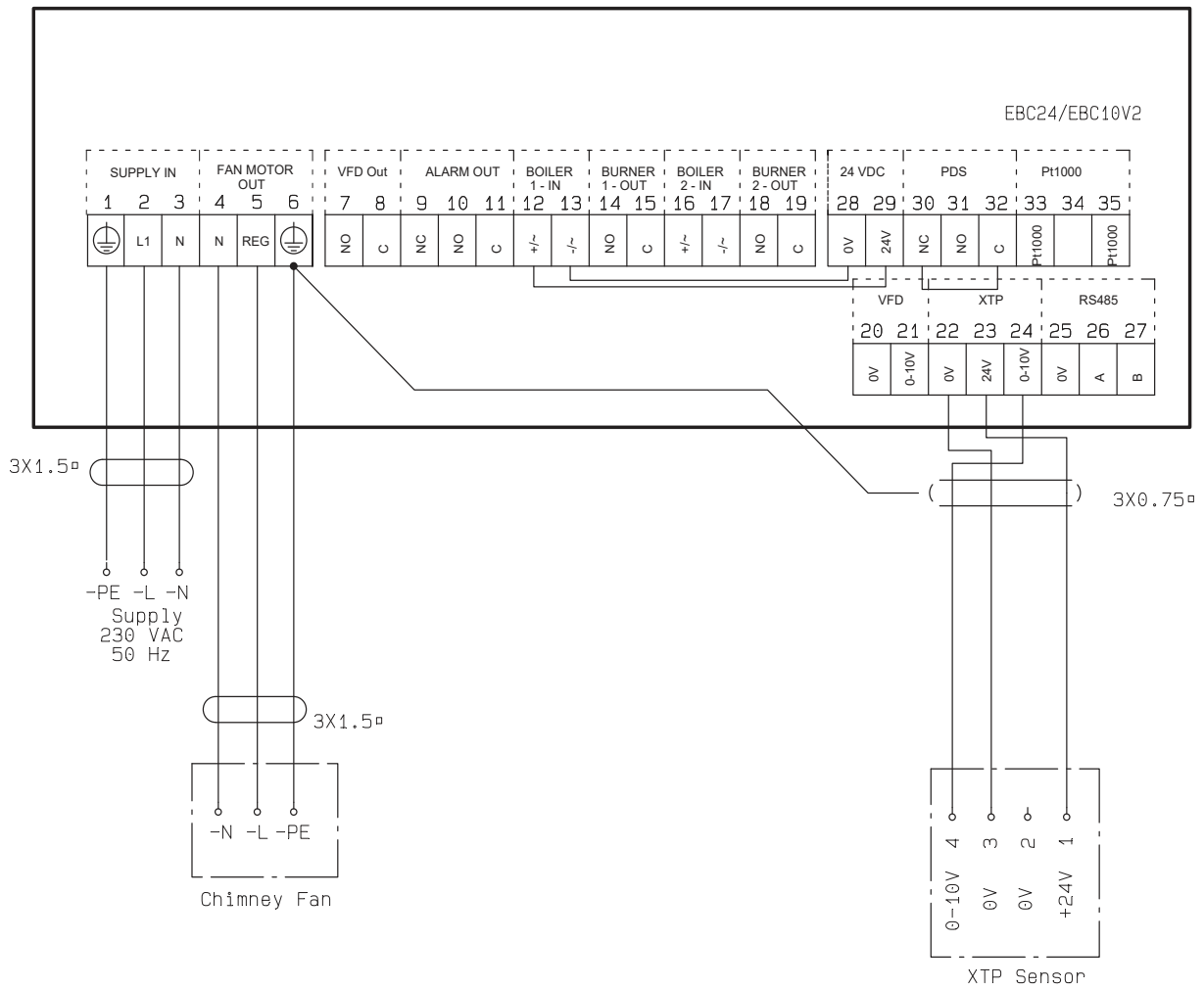

The example shows how a voltage signal (24 V DC) is connected to EBC10v2 for the chimney fan to run continuously

- Connect the supply to terminals 1-3.
- Loop terminals 12 and 29.
- Loop terminals 13 and 28.
- Connect the chimney fan to terminals 4-6.
- Connect the pressure transducer (XTP) to terminals 22-24 with a shielded cable, and connect the display to terminal 6.

One boiler with potential free contact

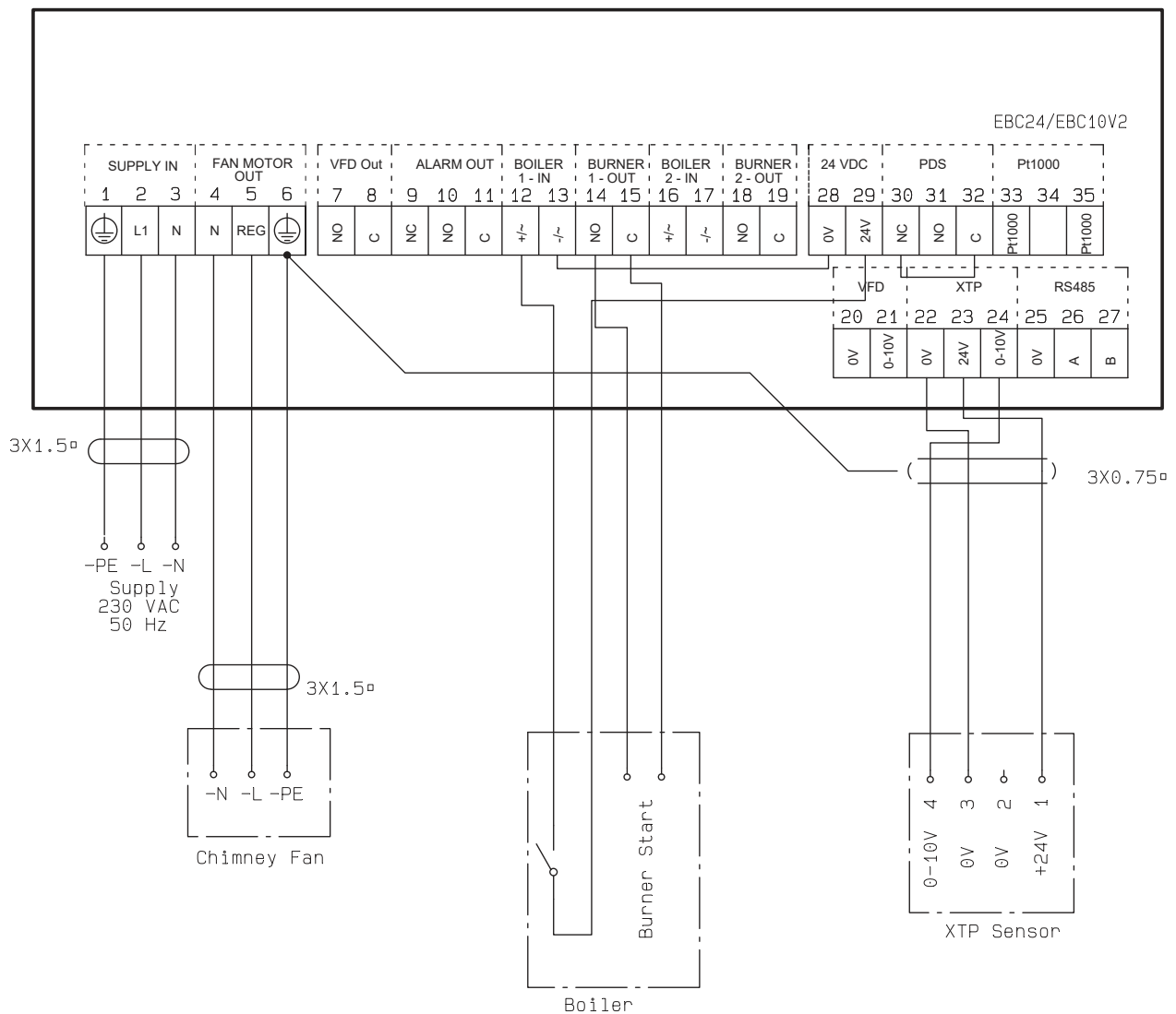

The example shows how a voltage signal (24 V DC) is connected to EBC10v2 for the chimney fan to run continuously

- Connect the supply voltage to terminals 1-3.
- Loop terminals 12 & 29.
- Loop terminals 13 & 28.
- Connect the chimney fan to terminals 4-6.
- Connect the pressure transducer (XTP) to terminals 22-24 with a shielded cable, and connect the display to terminal 6.

One boiler and extra monitoring with PDS

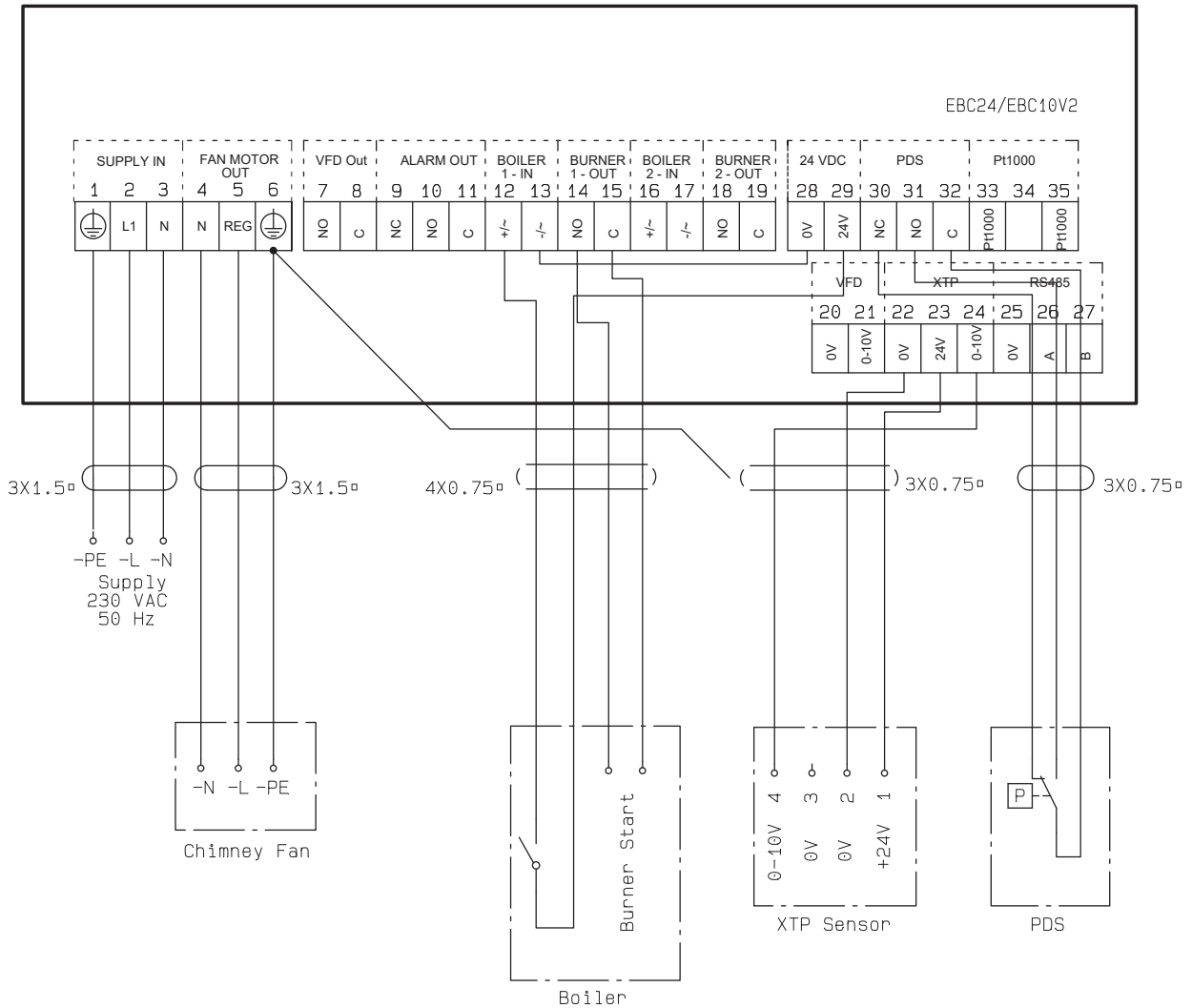

This example shows how to connect a potential free contact to the EBC10v2 to start/stop the fan

- Connect the supply to terminals 1-3.
- Connecting the boiler:
- Connect the potential free contact to terminals 12 & 29.
- Loop terminals 13 and 28.
- Connect the burner start signal to terminals 14 & 15.
- Connect the chimney fan to terminals 4-6.
- Connect the pressure transducer (XTP) to terminals 22-24 with a shielded cable, and connect the display to terminal 6.

One boiler with potential free contact and temperature sensor input

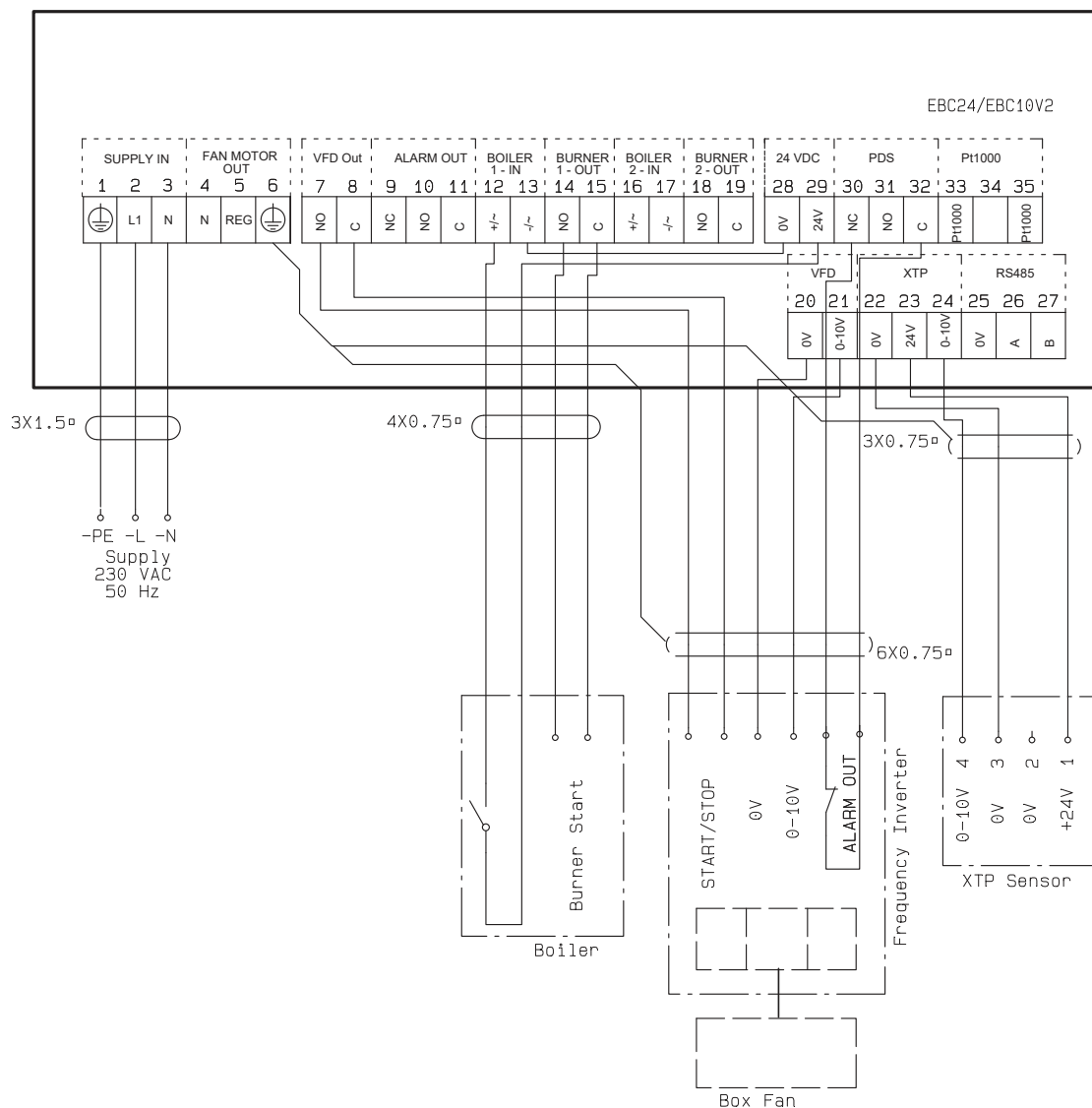

This example shows how to connect a PDS to EBC10v2. The PDS supplies extra monitoring

- Connecting PDS:
- Remove the factory installed wiring between terminals 30 and 32.
- Connect PDS to terminals 30, 31 and 32.
- Connect the supply to terminals 1-3.
- Connecting the boiler:
- Connect the potential free contact to terminals 12 & 29.
- Connect the burner start signal to terminals 14 & 15.
- Loop terminals 13 and 28.
- Connect the chimney fan to terminals 4-6.
- Connect the pressure transducer (XTP) to terminals 22-24 with a shielded cable, and connect the display to terminal 6.

Pressure regulation of Exodraft supply air fan

General Use

- The EBC10v2 can control a supply air fan directly or indirectly via a frequency inverter.

Positioning

Fit the EBC10v2 and pressure transducer (XTP) in the boiler room as described on page 12-13

Method of operation

General function

- The control system monitors the pressure in the boiler room and disconnects the burner in the event of errors (the alarmdiode on the EBC10v2 will turn on).
- When the pressure in the boiler room changes, the EBC10v2 will change the fan speed in order to meet the setpoint pressure for the boiler room.
- The EBC10v2 is linked to the boiler system in such a way that when a heating requirement arises, the EBC10v2 will start the fan and delay the start of the boiler until the pressure in the boiler room is sufficient.
- A safety function ensures that if the pressure in the boiler room is insufficient, the EBC10v2 will shut down the boilers.

Electrical connection



ATTENTION! This work must be performed by a qualified electrical engineer, in accordance with locally applicable rules and legislation.



The installation of the supply cable must be carried out in accordance with applicable regulations and legislation.

The earth terminal () must always be connected.

When connecting pressure transducer (XTP) and frequency inverter, screened cable must be used.

Isolation switch



Exodraft stresses that in accordance with EU's Machinery Directive an isolation switch must be set up in the fixed installation. The isolation switch is not supplied by Exodraft. Available as an extra.

Sample wiring diagram



The following sample wiring diagram shows how to connect the EBC10v2 to a frequency inverter/MPR relay. Exodraft recommends that you contact the boiler manufacturer for details of correct connection of the boiler control system.



UK Conformity Assessed



**Exodraft a/s
Industrivej 10
DK-5550 Langeskov**

Hereby declares that the following products:

EBC10v2EU01

Were manufactured in conformity with the provisions of the following regulations:

The Supply of Machinery (Safety) Regulations 2008

Electrical Equipment (Safety) Regulations 2016

Electromagnetic Compatibility Regulations 2016

Langeskov, 01-11-2022
Managing Director
Anders Haugaard



Declaration of Conformity

DK: EU-Overensstemmelseserklæring
 GB: Declaration of Conformity
 DE: EU-Konformitätserklärung
 FR: Déclaration de conformité de l'Union Européenne
 NO: EU-Samsvarserklæring
 PL: EU Deklaracja zgodności

NL: EU-Conformiteits verklaring
 SE: EU-Överensstämmelsedeklaration
 FI: EU-Vaatimustenmukaisuusvakuutus
 IS: ESS-Samræmisstaðfesting
 IT: Dichiarazione di Conformità Unione Europea



Exodraft a/s
Industrivej 10
DK-5550 Langeskov

Erklærer på eget ansvar, at følgende produkter:
 Hereby declares that the following products:
 Erklärt hierdurch auf eigene Verantwortung, daß folgende Produkte:
 Déclare, sous sa propre responsabilité, que les produits suivants:
 Erklærer på eget ansvar at følgende produkter:
 Niniejszym oświadczam, że następujące produkty:

Veklaart dat onderstaande producten:
 Deklarerar på eget ansvar, att följande produkter:
 Vastaa siltä, että seuraava tuote:
 Staðfesti à eigin àbyrgð, að eftirfarandi vörur:
 Dichiaro con la presente che i seguenti prodotti:

EBC10v2EU01

Som er omfattet af denne erklæring, er i overensstemmelse med følgende standarder:
 Were manufactured in conformity with the provisions of the following standards:
 Die von dieser Erklärung umfaßt sind, den folgenden Normen:
 Auxquels s'applique cette déclaration sont en conformité avec les normes ci-contre:
 Som er omfattet av denne erklæring, er i samsvar med følgende standarder:
 Zostały wyprodukowane zgodnie z warunkami określonymi w następujących normach:

Zijn vervaardigd in overeenstemming met de voorschriften uit de hieronder genoemde normen en standaards:
 Som omfattas av denna deklaration, överensstämmer med följande standarder:
 Jota tämä selvitys koskee, on seuraavien standardien mukainen:
 Sem eru meðtalin í staðfestingu Pessari, eru í fullu samræmi við eftirtalda staðla:
 Sono stati fabbricati in conformità con le norme degli standard seguenti:

EN 60335-1, EN 60335-2-80, DS/EN ISO 12100: 2011

I.h.t bestemmelser i direktiv:
 In accordance with
 Entsprechen gemäß den Bestimmungen der folgenden Richtlinien:
 Suivant les dispositions prévues aux directives:
 I.h.t bestemmelser i direktiv:
 Zgodnie z:

En voldoen aan de volgende richtlijnen:
 Enligt bestämmelserna i följande direktiv:
 Seuraavien direktiivien määräysten mukaan:
 Med tilvisun til ákvarðana eftirlits:
 In conformità con le direttive:

Maskindirektivet:
 The Machinery Directive:
 Richtlinie Maschinen:
 Directive Machines:
 Maskindirektivet:
 Dyrektywę maszynową:

De machinerichtlijn:
 Maskindirektivet
 Konedirektiivi:
 Vælaeftirlitið:
 Direttiva Macchinari:

2006/42/EF-EEC/-EWG/-CEE

Lavspændingsdirektiv:
 The Low Voltage Directive:
 Niederspannungsrichtlinie:
 Directive Basse Tension:
 Lavspenningsdirektivet:
 Dyrektywę Niskonapięciową

De laagspanningsrichtlijn:
 Lågspänningsdirektivet:
 Pienjännitedirektiivi:
 Smáspennueftirlitið:
 Direttiva Basso Voltaggio:

2014/35/EC

EMC-direktivet:
 And the EMC Directive:
 EMV-Richtlinie:
 Directive Compatibilité Electromagnétique:
 EMC-direktivet:
 Dyrektywę EMC – kompatybilności elektromagnetycznej

En de EMC richtlijn:
 EMC-direktivet:
 EMC-direktiivi:
 EMC-efirlitið:
 Direttiva Compatibilità Elettromagnetica:

2014/30/EC

Langeskov, 01-11-2022
 Adm. direktør
 Managing Director
 Anders Haugaard

Algemeen directeur
 Geschäftsführender Direktor
 Président Directeur Général
 Verkställande direktör
 Toimitusjohtaja
 Framkvemdastjóri
 Direttore Generale

DK: Exodraft a/s

Industrivej 10
DK-5550 Langeskov
Tel: +45 7010 2234
Fax: +45 7010 2235
info@exodraft.dk
www.exodraft.dk

SE: Exodraft a/s

Kalendevägen 2
SE-302 39 Halmstad
Tel: +46 (0)8-5000 1520
info@exodraft.se
www.exodraft.se

NO: Exodraft a/s

Storgaten 88
NO-3060 Svelvik
Tel: +47 3329 7062
info@exodraft.no
www.exodraft.no

UK: Exodraft Ltd.

24 Janes Meadow, Tarleton
GB-Preston PR4 6ND
Tel: +44 (0)1494 465 166
Fax: +44 (0)1494 465 163
info@exodraft.co.uk
www.exodraft.co.uk

DE: Exodraft a/s

Niederlassung Deutschland
Industriestraße 14
DE-55768 Hoppstädten-Weiersbach
Tel: +49 6782 989 590
Fax: +49 6782 989 5929
info@exodraft.de
www.exodraft.de

FR: Exodraft sas

78, rue Paul Jozon
FR-77300 Fontainebleau
Tel: +33 (0)6 3852 3860
info@exodraft.fr
www.exodraft.fr

Your energy. Optimized.

exodraft