

Control

# EHC20



UK | Read and save these instructions!

**exodraft**  
Your energy. Optimized.

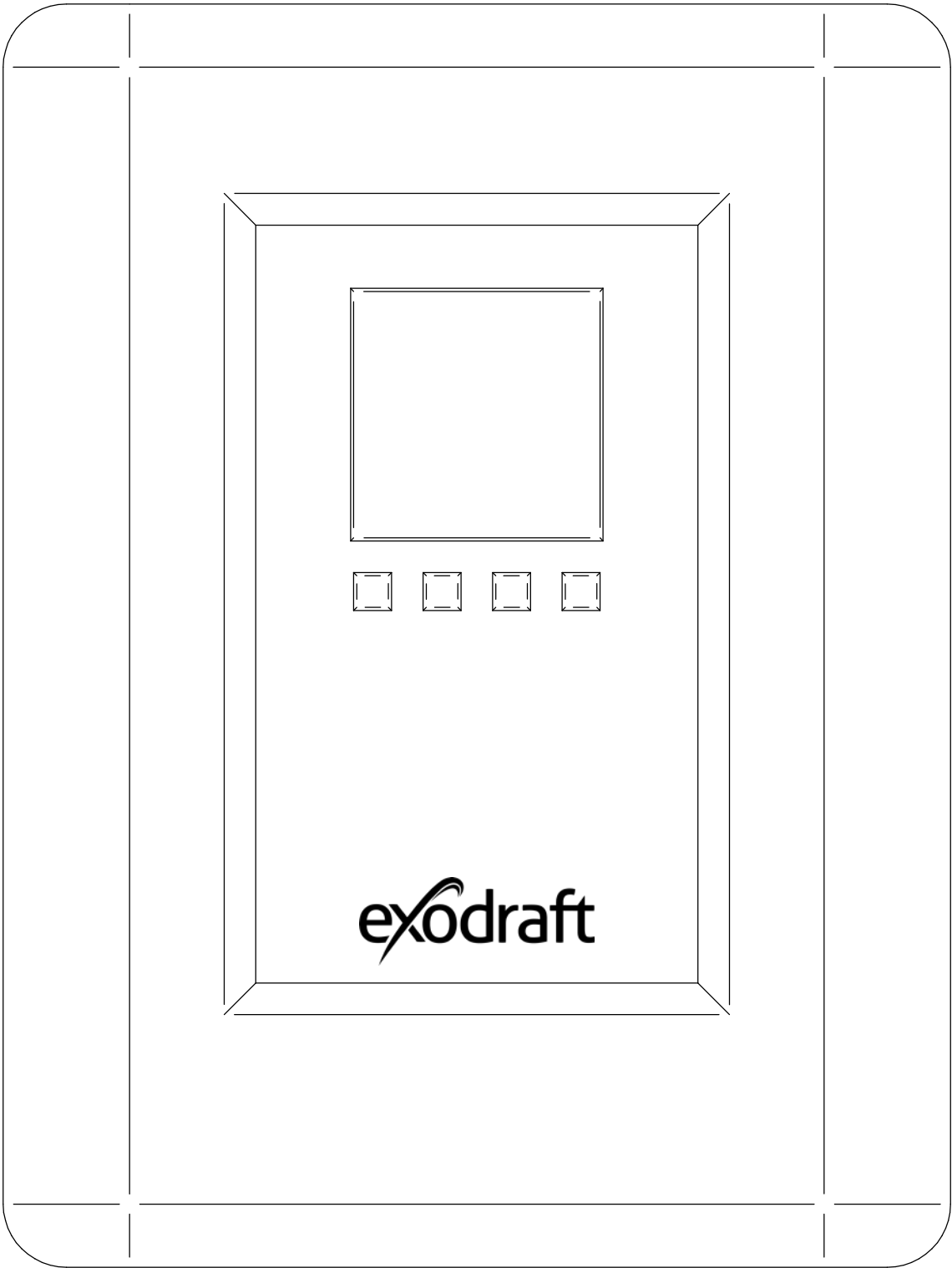

## Control | EHC20

# Content

---

<b>Product information</b>	<b>9</b>
Scope of supply	9
Accessories and spare parts	9
Warranty	10
<b>Installation</b>	<b>11</b>
Wall mounting	11
Electrical connection	12
Temperature sensor installation	13
<b>Terminal plan and connections</b>	<b>14</b>
Terminal housing	14
Terminal plan for electrical connection	14
<b>Connection diagram</b>	<b>15</b>
Program 6.1.7. SP, Safe Plate Heat Exchanger with bypass damper, one buffer tank and mixing valve.	15
Program 6.1.7. BP - Basic Plate Heat exchanger with bypass damper. With one storage tank and a mixing valve.	16
By high temperature in the heat exchanger in bypass mode the following solution will keep the circulation pump running until the S3 flow sensor is below the chosen setpoint.	18
<b>Installation note for 3-way mixing valve</b>	<b>19</b>
SM230 with MV20/25/32 installation note	19
<b>Service and start-up</b>	<b>20</b>
Display and entry	20
Initial start-up with the start-up assistant	21
<b>Lock menu</b>	<b>22</b>
Activate/deactivate the lock menu	22
<b>Option for heat quantity counter SE 20/SE 25/SE 32</b>	<b>23</b>
Assembly and connection	23
Start-up and set-up	24
To setup the Controller using the VFS follow the steps below.	24
<b>SD card</b>	<b>25</b>
SD card	25
Logging	25
Free storage	25
Load configuration	25
Save configuration	25
Firmware update	25
Ejection	25

---

<b>Error messages</b>	<b>26</b>
Replacing a fuse	26
Maintenance	27
<b>Product information</b>	<b>28</b>
Description	28
About the controller	28
Items supplied	29
<b>Controller description</b>	<b>30</b>
Technical data	30
Operation	32
Display and entry system	32
Setup wizard	33
Unassisted setup	33
Menu sequence and structure	34
<b>1. Measurements</b>	<b>35</b>
<b>2. Statistics</b>	<b>36</b>
2.1 Operating hours	36
2.2 Heat quantity	36
2.3 Graphic overview	36
2.4 Reports	36
2.5 Reset / delete	36
<b>3. Operating mode</b>	<b>37</b>
3.1 Automatic	37
3.2 Manual	37
3.3 Off	37
<b>4. Settings</b>	<b>38</b>
4.1 Tmin S (X)	38
4.2 Tmax S (X)	38
4.3 Priority S(X)	38
4.4 T priority	38
4.5 Filling time	39
4.6 Temperature rise	39
<b>5. Protective functions</b>	<b>40</b>
5.1 Anti-seize protection	40

---

<b>6. Special functions</b>	<b>41</b>
6.1 Program selection	41
6.2 Rotational speed control	41
6.3 R2 rotational speed control	45
6.4 Relay functions	45
6.5 Heat quantity	54
6.6 Pressure monitoring	55
6.7 Sensor calibration	56
6.8 Setup	56
6.9 Factory settings	57
6.10 SD card	57
6.11 Time and date	57
6.12 Summer time	58
6.13 Power saving mode	58
6.14 Temperature unit	58
<b>7. Menu lock</b>	<b>58</b>
<b>8. Service data</b>	<b>59</b>
<b>9. Language</b>	<b>59</b>
<b>Faults with error messages</b>	<b>60</b>
Replace fuse	60
Maintenance	61
<b>Useful information / tips and tricks</b>	<b>62</b>
<b>UK Conformity Assessed</b>	<b>63</b>
<b>Declaration of Conformity</b>	<b>64</b>



## How to use this manual

*This manual has been prepared based on the specific product and contains relevant technical information and installations guides.*

*Accessories and spare parts are not covered by this manual. Please refer to the individual manuals of these components.*

*This installation manual does not contain any system design documentation.*

*Failure to observe instructions marked with a danger symbol may result in personal injury and/or damage to the product.*

Errors and omissions excepted.



## Disposal

Electrical and electronic equipment (EEE) often contain materials, components and substances that may harm the environment or be hazardous to your health. Products (WEEE) marked with the 'crossed-out wheeled bin' symbol should be disposed of separately from other waste at the end of its life. Though legislation may differ from country to country we strongly advise that electrical and electronic waste is separated from other waste and disposed of according to national legislation to protect the environment and personnel that may come into contact with waste.

# Symbols

The following symbols may be used in the manual to draw attention to danger or risk of personal injury or damage to the product.



## General prohibition

Failure to observe instructions marked with the prohibited symbol may result in extreme danger or serious personal injury.



## General attention

Marks a dangerous situation that, in the worst-case scenario, can cause serious personal injury or significant damage to the product.



## General warning

Failure to observe instructions marked with a danger symbol may result in personal injury and/or damage to the product.



## Electricity hazard/High Voltage

Marks a situation in which caution is advised due to the risk of high voltage electric shock which can cause serious personal injury or significant damage to the product.



## Connect an earth terminal to the ground

Failure to observe instructions marked with a danger symbol may result in personal injury and/or damage to the product.



## Permitted and approved

Permitted and approved method of installation.



## Prohibited and not approved

Prohibited and not approved method of installation.



## Warning

To minimise the risk of fire, electric shock, personal injury and/or damage to the product please observe the following:

- Please always read the manual and only use the product in accordance with the manufacturer's instructions. If in doubt, contact one of the Exodraft specialized dealers.
- All installations must be carried out by properly qualified personnel in accordance with national legislation and regulations.
- This product must be earthed. Get assistance from an qualified electrician when in doubt.
- This product must always be disconnected under the installation.
- Prior to servicing the product, disconnect the power and ensure that it cannot accidentally be reconnected.
- Exodraft always recommends the use of a smoke alarm when a solid fuel open fire is installed.
- If the Exodraft fan system has been designed for solid fuel/multi fuel installations, please ensure that the design meets the requirements of BS EN15287-1. If this cannot be achieved, a smoke alarm must be installed in the same room as the heat appliance.



## Product information

The EHC20 temperature difference controller enables you to efficiently use and check the function of your heat exchanger. Above all, the device gives you confidence through its functionality and simple, almost self-explanatory, operation. The individual entry keys are assigned to each different useful function and explained step-by-step. In the automatic controller menu, help texts and clear graphics are also available in addition to keywords for measured values and settings.

The EHC20 temperature difference controller can be used with different systems.

Incorrect use may result in problems with soot, chimney fires, etc. which might damage the product. Please check out this site for advice about the product:

[www.exodraft.com](http://www.exodraft.com)

## Scope of supply

- Exodraft EHC20
- Three screws (3.5 x 35 mm) and three rawl-plugs (6 mm) for wall mounting
- 12 strain relief clamps with 24 screws, replacement fuses 1x T2 A / 250 V
- Micro SD card + adapter
- One Pt1000 flue gas temperature sensor
- One Pt1000 pipe surface temperature sensor
- One Pt1000 Buffer tank sensor with sleeve
- Installation manual and user instructions



Please use thermal compound with the temperature sensors to ensure better heat transfer.

## Accessories and spare parts

The table below shows the accessories and spare parts available for the EHC20.

Accessories*
Flowsensor for energy measurement (optionally included, depending on design/order)

\*This manual does not describe the specific use of accessories. We refer to the separate manuals for such components.

For more details contact your Exodraft dealer.

## Warranty

All Exodraft products are covered by a 2-year guarantee as per European consumer rights legislation. For some countries an extended period of guarantee may apply depending on either national legislation or other clearly stipulated conditions. Customer complaints must be handled by a specialised dealer or wholesaler (preferably where the Exodraft product has been bought originally). An updated list of Exodraft specialised dealers can be found on our website for the country in question.

Exodraft products must always be installed by properly qualified personnel. Exodraft reserves the right to change these guidelines without prior notice.

The warranty and liability does not cover instances regarding personal injury or damage to property or the product that can be ascribed to one or more of the following causes:

- Failure to follow this installation and operation manual
- Incorrect installation, start-up, maintenance or servicing
- Improper repairs
- Unauthorised structural modifications made to the product
- Installation of additional components that have not been tested/approved with the product
- Any damage resulting from continued use of the product despite an evident defect
- Failure to use original spareparts and accessories
- Failure to use the product as intended
- Exceeding or failure to meet the limit values in the technical data
- Force majeure

# Installation

## Wall mounting

1. Loosen cover screw completely
2. Carefully remove the terminal cover from the bottom part. Loosen the two screws on the top part and remove the top part from the base.
3. Mark the three mounting holes (see "Housing base" below). Make sure that the wall surface is as even as possible so that the housing is not warped when attached.
4. For mounting the controller on a brick or concrete wall drill three 6 mm holes in the wall at the marked places. Insert the rawplugs that came with the controller into the holes.
5. Set the automatic controller on the upper screw.
6. Insert and screw in the two lower screws.



Only install the automatic controller in dry rooms and under the environmental conditions as described above.



The automatic controller must not be accessible from the back!

## Housing base

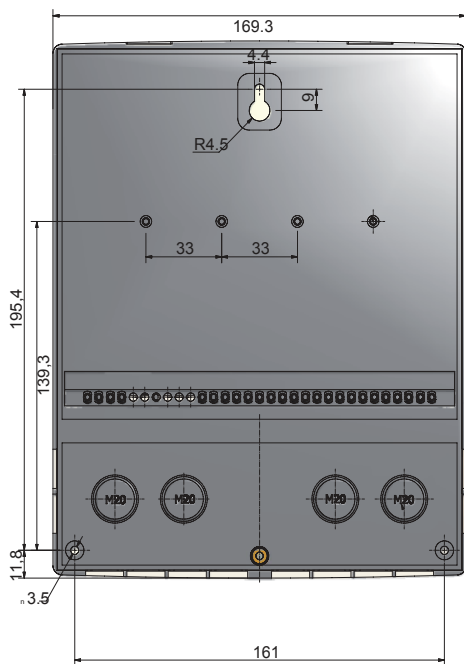

## Housing cover

Terminal housing cover

Cover screw

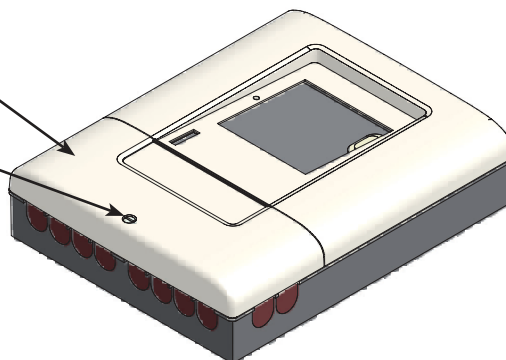

## Electrical connection



Disconnect the power supply before working on the device and make sure that it cannot be reconnected! Check that the power is off!

The electrical connection must only be carried out by qualified personnel in compliance with the applicable laws. The automatic controller must not be put into operation if any damage is visible on the housing, such as cracks.



Low-voltage cables such as temperature sensor cables must be routed separately from mains voltage cables. Only put temperature sensor cables into the left side, and the mains voltage cable into the right side of the device.



Safe isolation of the voltage supply to the automatic controller has been provided, such as provision for an overheating emergency stop switch.



The cables to be connected to the device may be stripped up to maximum of 55 mm and the sheath should reach into the housing to exactly behind the strain relief.



The automatic controller and VFS sensor must have the same earthing potential. The VFS sensor has a functional earthing (PELV). The PE terminal of the automatic controller must be connected to the the piping system near the sensor.

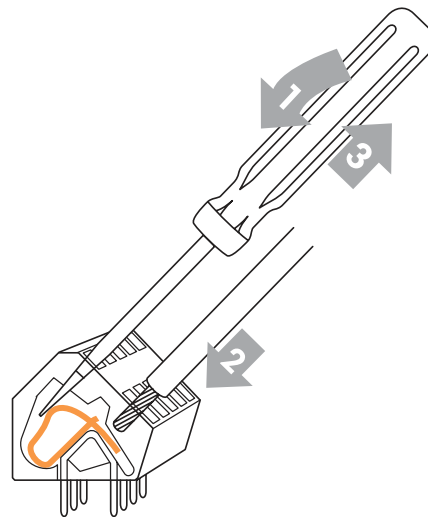
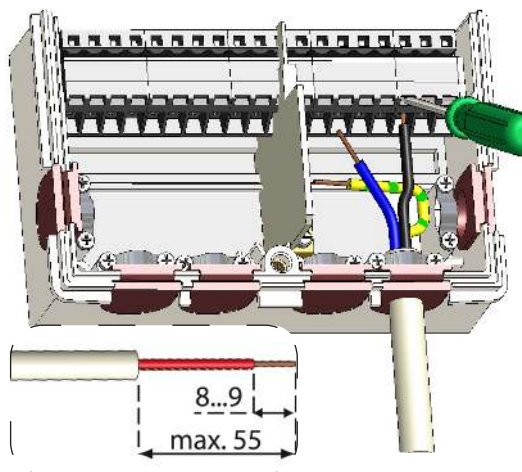

### Terminal instructions

1. Insert a suitable screwdriver into the upper opening and press the locking spring down. Leave the screwdriver in the opening.
2. Insert the cable into the lower opening.
3. Remove the screwdriver.

## Temperature sensor installation

The automatic controller works with Pt1000 temperature sensors to ensure that the temperature is precisely recorded.



The temperature sensor cables must be placed separately from the mains cables to avoid interference in the temperature readings and must not, for example, be placed in the same cables duct!



Install the sensor in the area to be measured! Only use the appropriate immersion sensor, surface contact sensor with the appropriate permissible temperature range for the respective area of the application. The surface contact sensor must be installed using thermal paste between the pipe surface and the sensor contact flate.



The sensor cables to S7/S8 may be extended to a maximum total length of 30 metres with a cable that has a diameter of at least 0.75 mm<sup>2</sup>. The sensors from S1 to S6 may be extended to a maximum total length of 10 metres with a cable that has a diameter of at least 0.75 mm<sup>2</sup>.

Pay attention that no contact resistance occurs while joining the cables!



Connect the VFS direct sensors with the corresponding plug. In order to avoid damage to the direct sensors, we strongly recommend only placing them in the return flow! Pay attention to the correct flow direction when assembling the (VFS) direct sensors!



# Terminal plan and connections

## Terminal housing

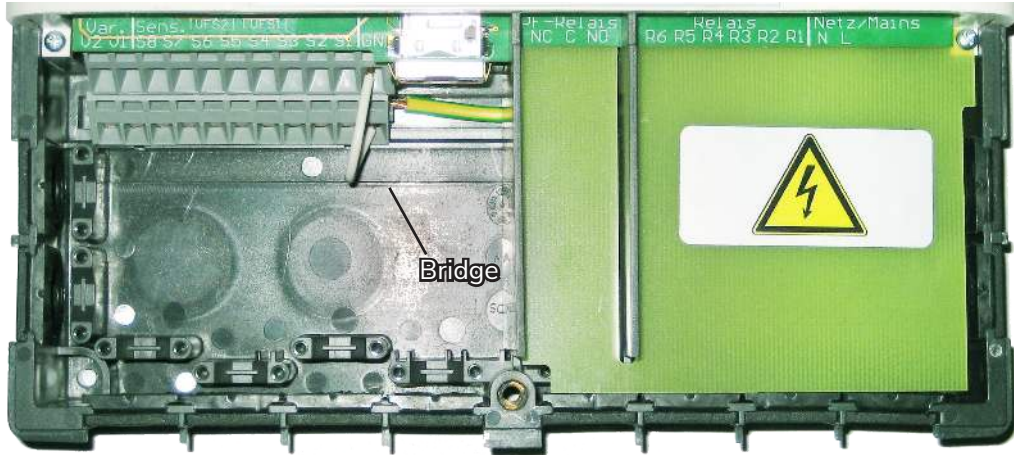
The mains side of the terminal housing is protected on the right side by an additional plastic plate. Before removing the plate, check that the power to the automatic controller has been switched off.



## Terminal plan for electrical connection

<p> max. 12 V</p> <p><b>Extra-low voltages</b> max. 12 VAC/DC</p> <p><u>Terminals</u> Connection for</p> <p>S1 Sensor 1 S2 Sensor 2 S3 Sensor 3 S4 Sensor 4 S5 Sensor 5 S6 Sensor 6 S7 Sensor 7 S8 Sensor 8</p> <p>V1 0-10 V/PWM V2 0-10 V/PWM VFS1 Grundfos Direct Sensor VFS2 Grundfos Direct Sensor RC Room controller</p>	<p><b>SD card slot</b></p> <p>for data storage and updates</p> <p></p> <p>Ensure you insert the card correctly! The card must enter without any resistance, do not force it into the slot!</p>	<p><b>Potentially free relay</b></p> <p>NO Normally open (closer)</p> <p>C Common (Voltage)</p> <p>NC Normally closed (opener)</p>	<p> Mains 230 VAC</p> <p>Mains voltages 230 VAC 50-60 Hz</p> <p><u>Terminals</u> Connection for</p> <p>R1 Switch output 1 (speed) R2 Switch output 2 (speed) R3 Switch output 3 R4 Switch output 4 R5 Switch output 5 R6 Switch output 6</p> <p>N Mains neutral cable N L External mains line conductor L</p> <p>The peripheral unit protective earth must be connected at the peripheral unit of the metal terminal block!</p>
--	---	--	--

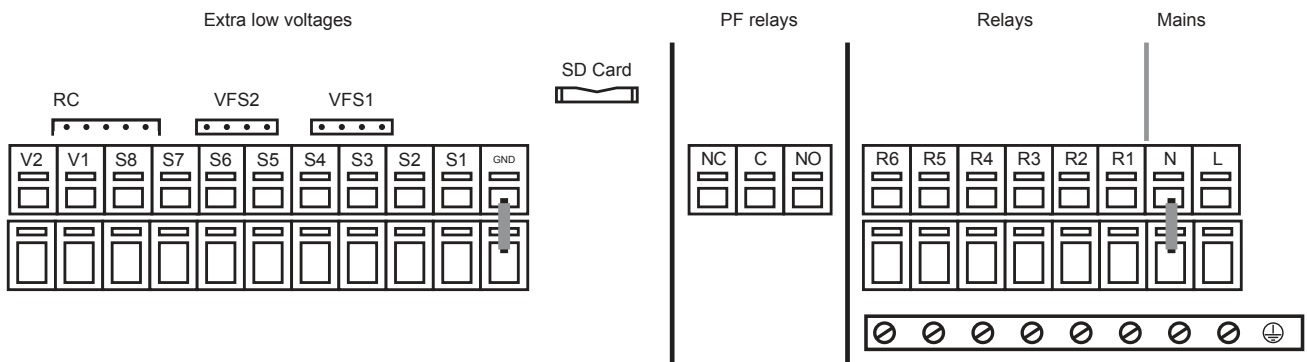

## Connection diagram

### Program 6.1.7. SP, Safe Plate Heat Exchanger with bypass damper, one buffer tank and mixing valve.

This diagram shows the following system:

Heat exchanger SP with built-in bypass damper. A buffer tank, a mixing valve and a circulating pump.

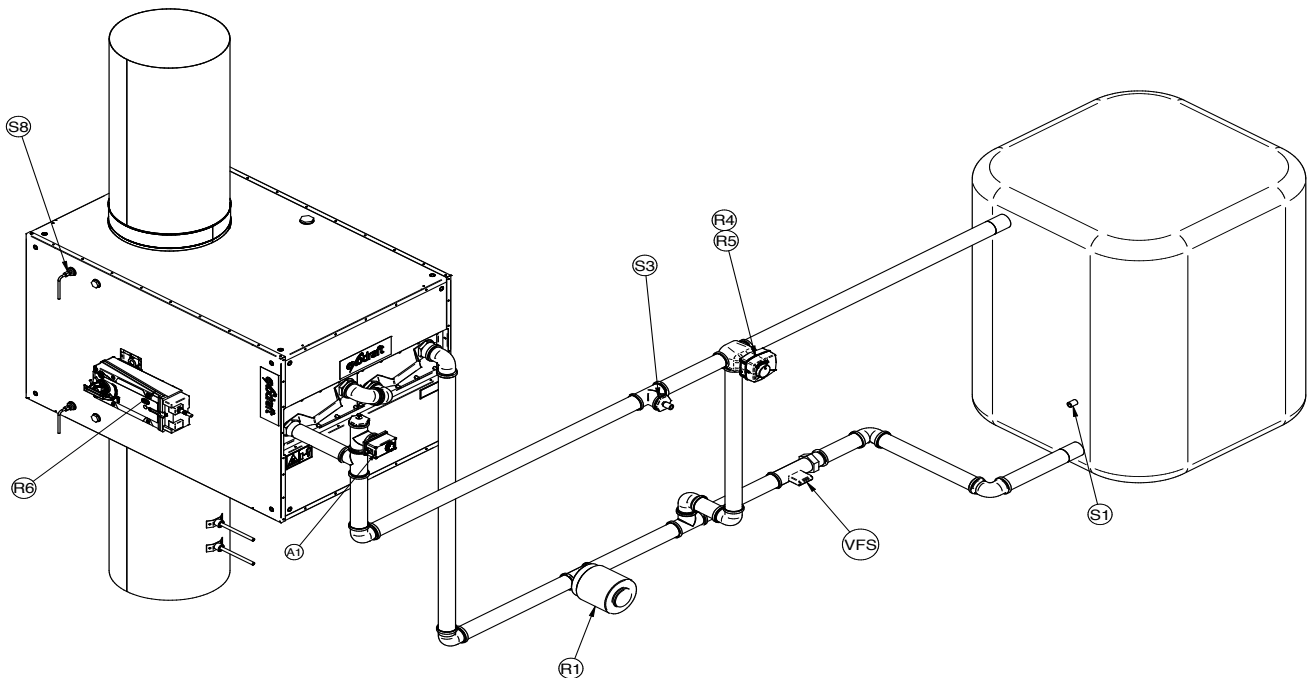

Place the S8 temperature sensor in the entry of the heat exchanger.

Mount the S3 temperature sensor on the supply pipe immediately behind the circulating pump.

Mount the S1 temperature sensor in the lower part of the buffer tank.

VFS is the energy sensor for heat quantity measurement – optionally available.

A1 is the STB safety temperature limiter. Warning: only use with external sensors!

The mixing valve should be mounted on R4 (brown/black) and R5 (black/brown). See SM230 with MV20/25/32 on page 9 of the installation guide.

Mount the circulating pump on the R1 terminal.

Mount the bypass motor on the R6 terminal.

The lower terminal strip is the minus pole and/or the neutral point.

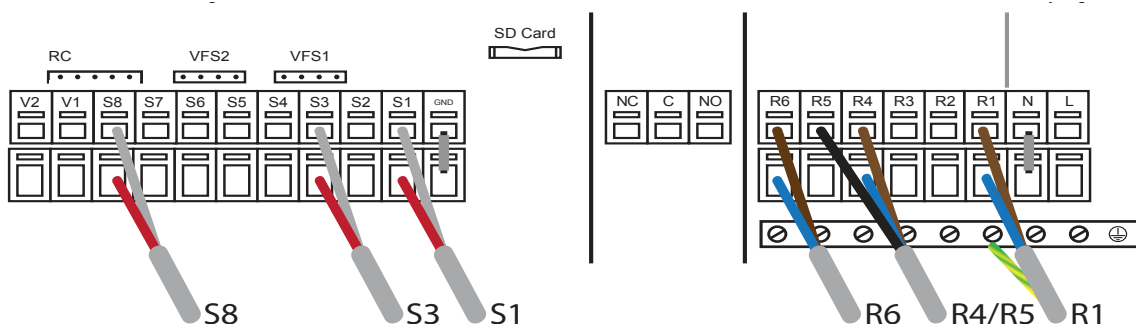

An STB safety temperature limiter must be mounted in the supply and must close the bypass damper at a temperature of 100°C!

## Program 6.1.7. BP - Basic Plate Heat exchanger with bypass damper. With one storage tank and a mixing valve.

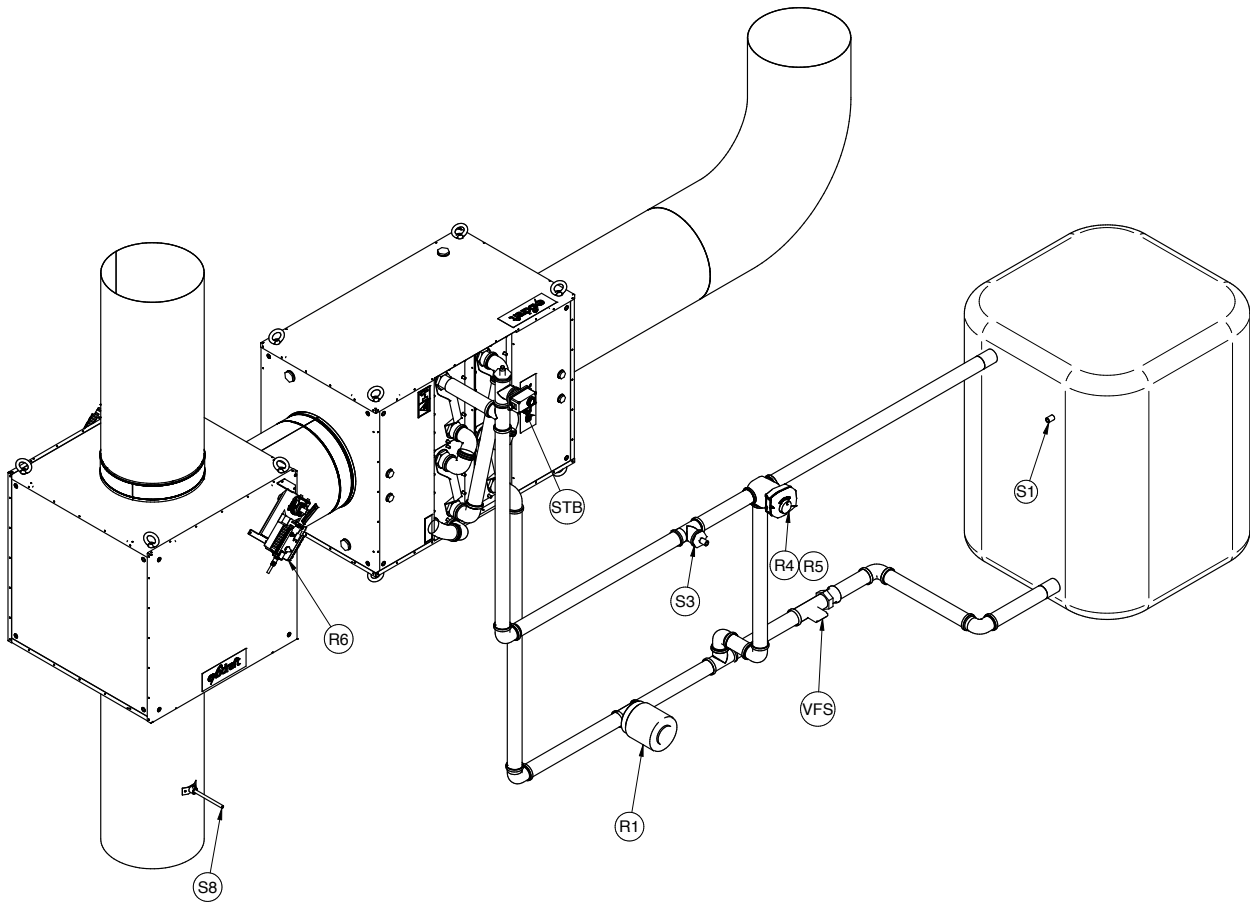

The S8 temperature sensor must be installed in the main chimney before the entry of the bypass damper.  
The S3 temperature sensor must be mounted on the forward flow pipe between the heat exchanger and the mixing valve.

Mount the S1 temperature sensor in the lower part of the buffer tank.

VFS is the energy sensor for heat quantity measurement – optionally available.

A1 is the STB safety temperature limiter. Warning: only use with external sensors!

The mixing valve should be mounted on R4 (brown/black) and R5 (black/brown). See SM230 with MV20/25/32 on page 9 of the installation guide.

Mount the circulating pump on the R1 terminal.

Mount the bypass motor on the R6 terminal.

The lower terminal strip is the minus pole and/or the neutral point.



This diagram shows wiring diagram for program version 6.1.7 both covering SP, Safe Plate and BP, Basic Plate installations:

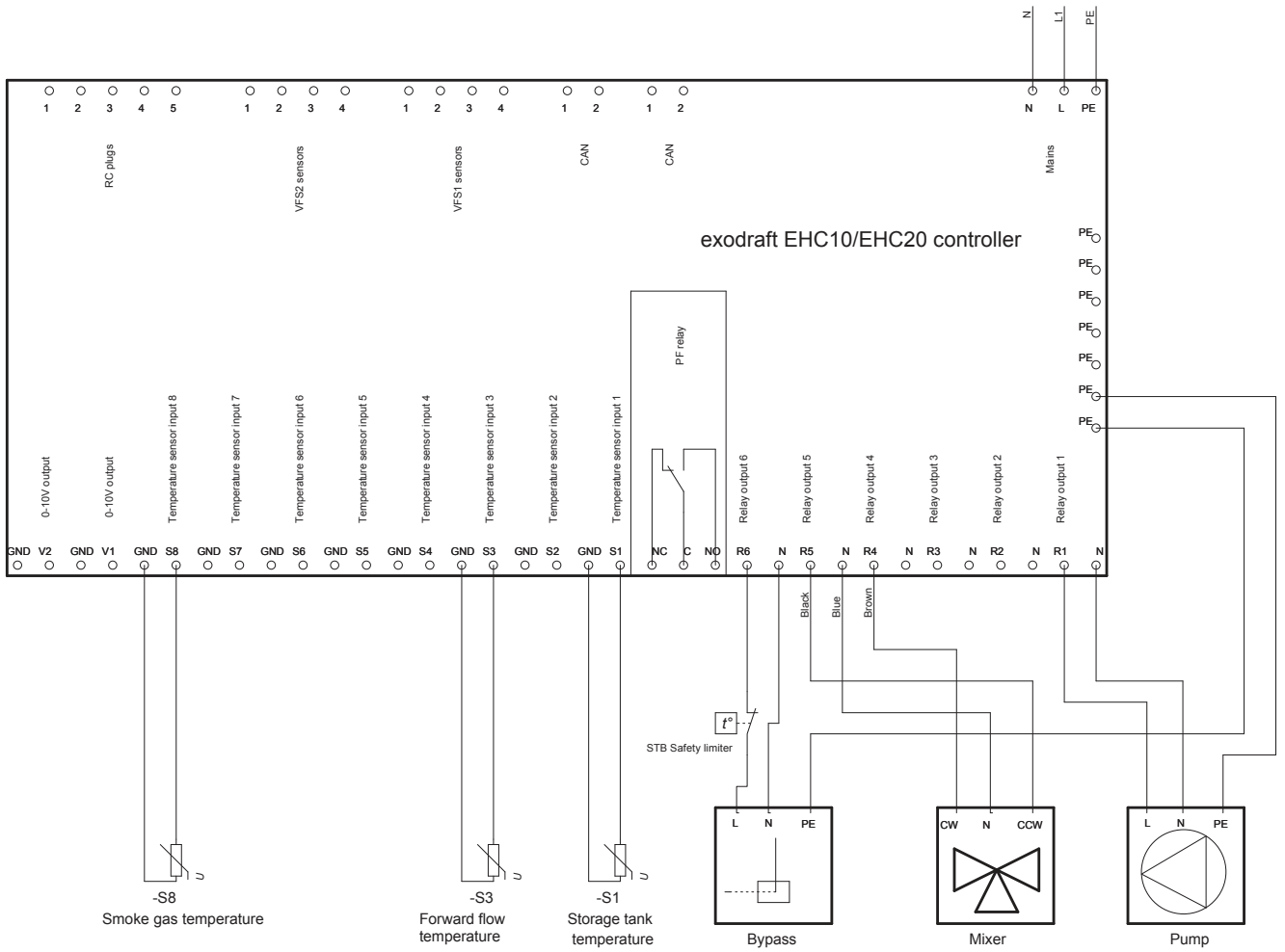

## By high temperature in the heat exchanger in bypass mode the following solution will keep the circulation pump running until the S3 flow sensor is below the chosen setpoint.

The temperature in the heat-exchanger can become too high when the heat source stops and the temperature S8 drops below the set-point. A solution for this is described below.

### Connect the pump according to this diagram

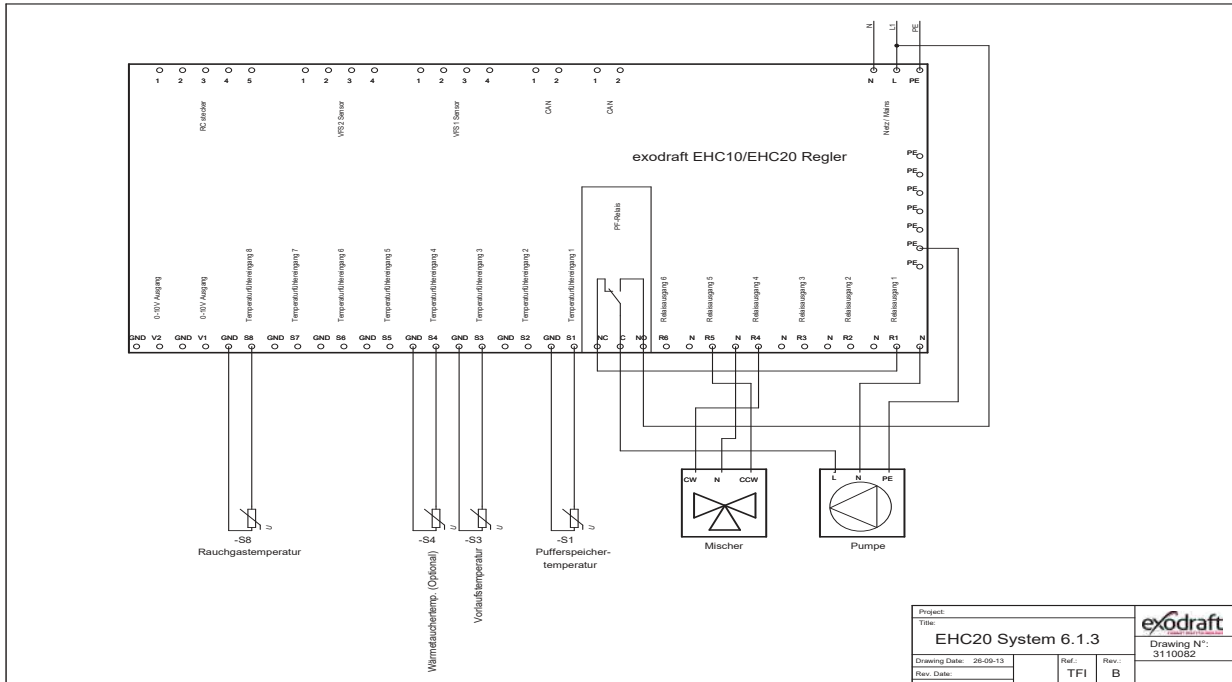

- In the menu go to „ Special functions“
- Choose menu point „Relay 7“ off
- Choose menu sub-point „Thermostat“ off
- Press confirm and choose „ON“
- Set the Tset on 80°C
- Change thermostat sensor to S3
- Optional: Mount an S4 temperature sensor on the chassis of the heat-exchanger module and change the thermostat sensor to S4.

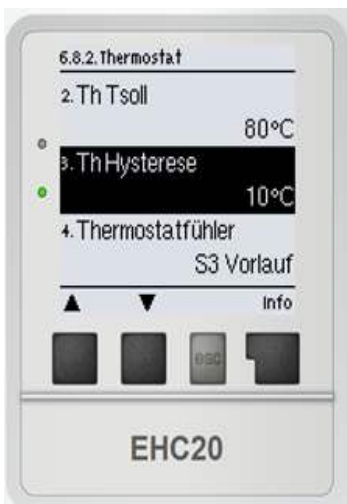

## Installation note for 3-way mixing valve

Please pay attention to the installation note during use of the Exodraft SM230 with MV20 three-way mixing valve.

 When using a different three-way mixing valve, please pay attention to the flow direction during installation!

### SM230 with MV20/25/32 installation note

Pay attention to the basic setting of the mixing valve and flow direction before installing the MV20/25/32!

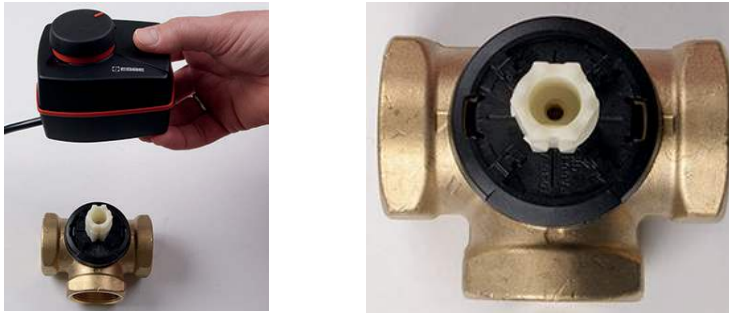

The drive axle notch must be in the centre of the valve exit.

Please pay attention to the mixer setting in case of a change in flow direction:

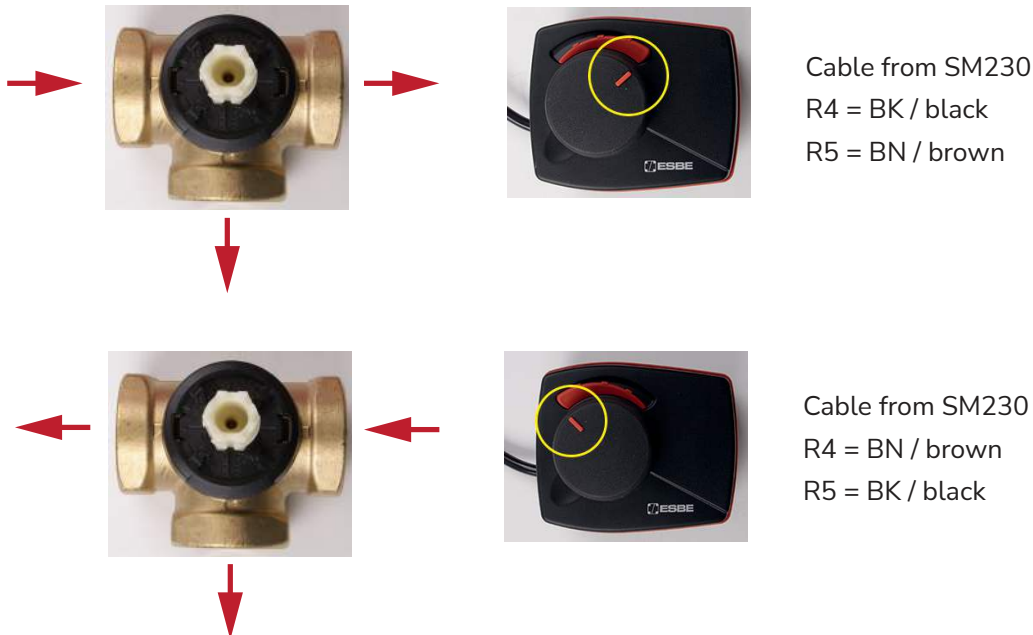

Connect the actuator to the valve by inserting the actuator over the valve spindle, fasten the actuator using the screw from the mounting kit.

To engage the actuator to the valve spindle, press the big center knob all the way in until it "clicks" into place. The actuator can be disengaged from the valve again by pulling the knob out again.

# Service and start-up

## Display and entry

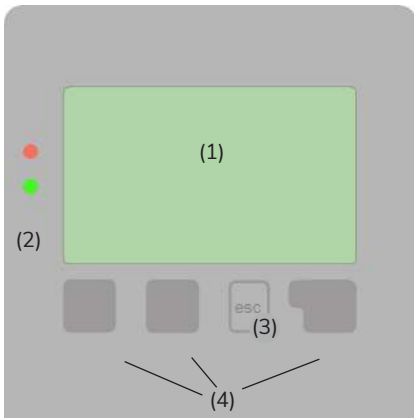

The display (1), which has extensive text and graphics modes, makes servicing the automatic controller both simple and almost self-explanatory.

Please press the ESC key to return to the main menu.

The green LED status light (2) illuminates when a relay is switched on, the red LED light blinks in the event of an error message or when saving information.

Entries are made with 4 keys (3+4) that have various functions, depending on the situation. The ESC key (3) is used to interrupt an entry or leave a menu.

When changing settings in the controller you will, before saving the changes, be asked if you wish to save the complete changes. If you do not want to save the changes you can press ESC.

The function of the three buttons (4) are explained for each menu, directly above the keys; The key on the right side, is usually used to confirm changes and select menus.

### Examples of key functions

+/-	Increase/Reduce values
▼/▲	Menu scroll up/down
YES/NO	Accept/Decline
Information	Further information
Back	about the previous display
OK	Confirm selection
Confirm	Confirm setting

### Examples of display symbols

	Pump (swivels when in operation)
	Valve (black indicates the direction of flow)
	Storage
	Temperature sensor
	Heat exchanger
	Charging pause (see charging time)
	Warning /Error message
	New information available
	Logging switched on

You can find other symbols explained in the special functions menu.

## Initial start-up with the start-up assistant

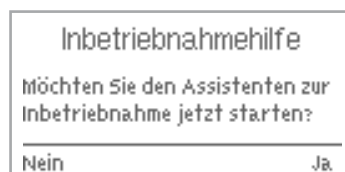

The start-up assistant will appear when you switch on the device for the first time and will guide you through the following menu:

1. Choose language → press OK to confirm
  2. Time and date → adjust with the arrow keys and press OK to confirm each selection. Press ESC to return to the previous menu.
  3. Run start-up assistant → press OK to confirm
- The start-up assistant can also be terminated at any time and later restarted from the special function menu.

4. Would you like to launch the start-up assistant? → Press YES and follow the menu
5. Select 6.1.7 for mixer with bypass and one buffer memory by using the arrow keys → Press OK to confirm.
6. Follow the menu and set the following values, then press OK to confirm:

Designation/Description	Factory settings	Should be set Yes: √/No: 0 /Confirm	Recommended value	Start-up values
6.20 Temperature unit	°C	Confirm		
4.1 Tmin S8 – Heat exchanger temperature sensors	60°C	Confirm		
4.4 ΔT S8, S1 - temperature differential	10/3°C	Confirm x 2		
4.5 Tmax S1 – Desired buffer memory temperature	60°C	Confirm/Use arrow keys to change and confirm	90°C	
6.2.1 Rotation speed R1	OFF	Confirm		

7. The display shows that the commissioning is finished and further setting can be done in special functions or settings. Press Continue to finish.
8. Close and save → Press YES to confirm

Congratulations! You have completed the start-up!

After a successful start-up, the menu will automatically close.



If the start-up assistant does not launch automatically, then it can be launched manually. Press ESC to go to the main menu and select "6. Special functions". Select "12. Start-up" on the menu and press OK.



**IMPORTANT!** Follow the steps below to activate PUMP POST RUN:

Press Escape to go to main MENU.

Scroll down to go to MENU 5, PROTECTIONS

Press OK

Select MENU 2, PUMP POST RUN

Press OK

Select 1. PUMP POST RUN

Press INFO

Press "+" to select ON

Press CONFIRM

Scroll down to choose 2, PUMP POST RUNTIME

Press INFO to enter menu

Press CONFIRM to accept post run time

Press ESCAPE to leave menu

## Lock menu

The lock menu is used to prevent any unintentional changes to the entered values.

The following menu items remain fully accessible when the lock menu has been activated and can be adapted as needed:

1. Measured values, 2. Evaluation, 6.23. Time & date, 8. Lock menu, 9. Service values

## Activate/deactivate the lock menu

To activate/deactivate the lock menu, press ESC to return to the main menu and use the arrow keys to select menu point "7. Lock menu."

It will indicate whether the lock menu is activated or not.

Press INFO to change the status of the lock menu.

1. Use the arrow keys to activate/deactivate the lock menu and press OK to confirm.
2. Leave the menu by pressing ESC.
3. "Save changes?" -> press YES to confirm

You can press ESC now to leave the main menu.

## Option for heat quantity counter SE 20/SE 25/SE 32

The integrated VFS heat quantity counter and flow quantity meter (optional equipment) can be used to measure the amount of recovered heat.

**The Heat Quantity Counter gives a calculated amount of saved energy but should not be used for accounting purposes!**

### Assembly and connection

When installing the heat quantity counter (WPS), it is vital to pay attention to the flow direction, because otherwise correct functioning cannot be ensured.

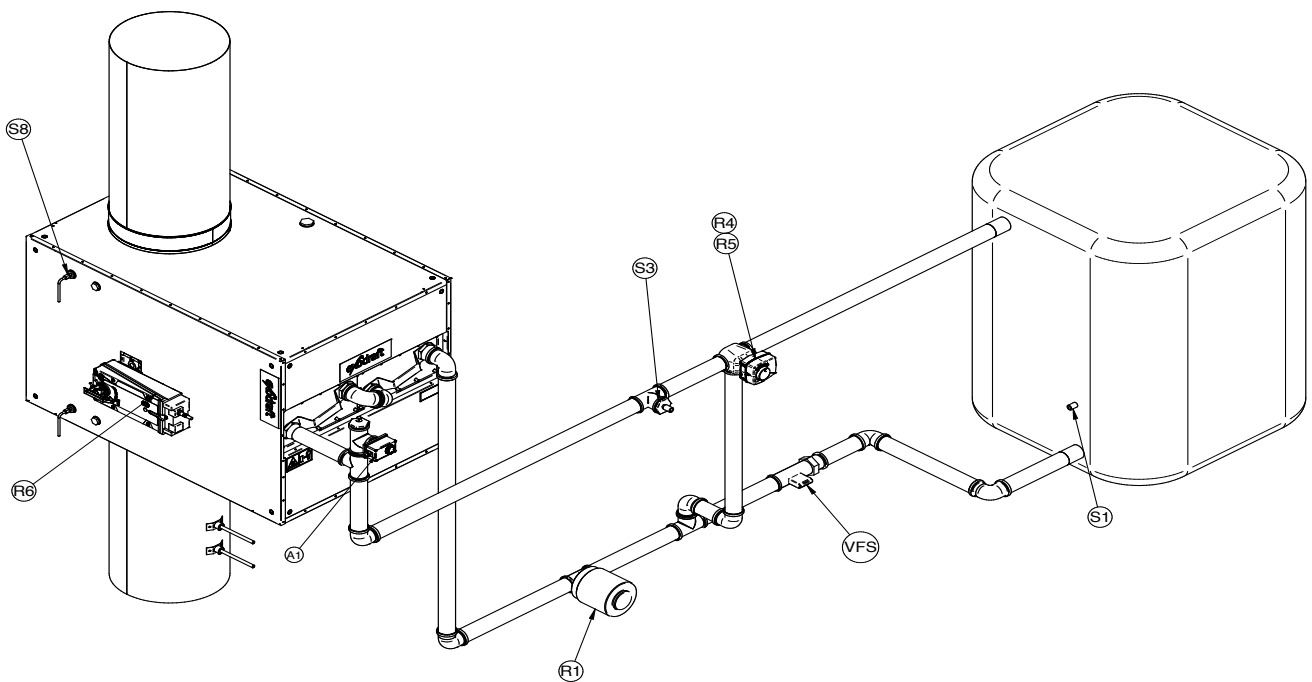

Connect the EHC20 by inserting the plug in the VFS1 connection socket.

### Connector for energy sensor

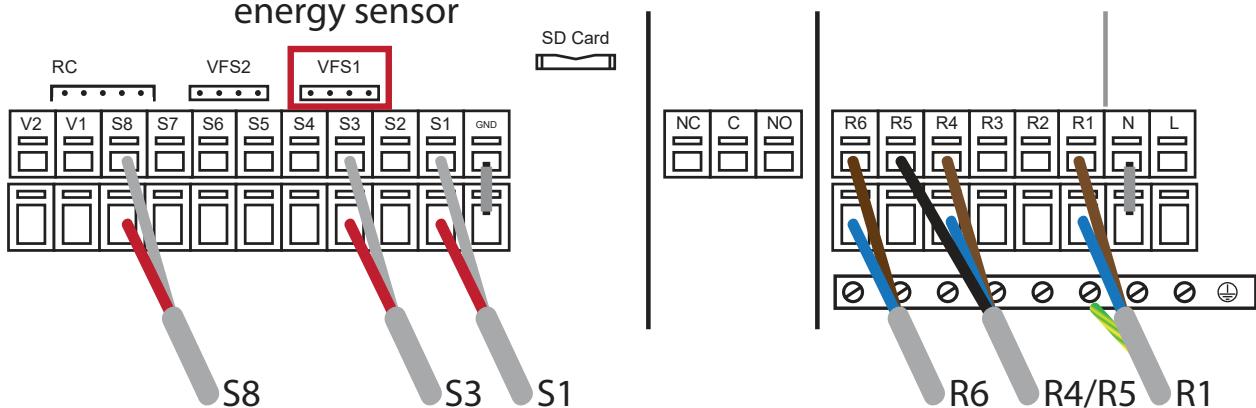

## Start-up and set-up

To setup the Controller using the VFS follow the steps below.

1. Go to main menu ->
2. Select menu number 6 "Special Functions"
3. Go to menu number 9 " Heat quantity"
4. Move cursor to select "VFS1". Press "Info"
5. Select the type of VFS. (Sensor volume flow interval is required) (Standard setting = Off).
6. Use + or - to navigate between the predefined sensor intervals.
7. Confirm that the VFS is installed in Return Flow.
8. Select the reference temperature to S3.
9. Select type of antifreeze liquid.
10. Enter amount of antifreeze liquid in the system. (If there is no antifreeze liquid in the system enter 0%)
11.  $\Delta T$  offset Heatmetering correction factor.
12. To calculate correct heat yield, the two temperature sensors used for this, must be calibrated.



## SD card

You can store the current configuration, measurement results, etc. on the included SD card or overwrite a software update on the automatic controller.

To do this, press ESC to go to the main menu and select "6. Special functions" and then select menu item "14. SD card"

## SD card

Setting the logging function with data storage on the SD card.

## Logging

In this menu, the sensor and relay data recording is activated or deactivated.

The display shows whether logging is activated or deactivated.

To change this, press INFO and use the +/- key to select "ON" or "OFF" and confirm.

**It must be set to "ON" to activate the sensor and relay data recording.**

## Free storage

This displays the available storage space on the SD card.

## Load configuration

This function allows you to load all the automatic controller settings on the SD card.



All previous settings in the automatic controller will be overwritten.

## Save configuration

This function allows you to save all the settings in the automatic controller, including the service values, onto the SD card.

To do this, press the ESC key to go to the main menu.

## Firmware update

This function copies firmware that has been saved on the SD card to the automatic controller.



Never switch off or disconnect the automatic controller during a firmware update – this can cause irreparable damage. Settings may be changed and/or overwritten. Reset the automatic controller back to the factory settings after any firmware update and perform a new start-up.

## Ejection

To prevent any damage or loss of data, you must safely log-out before ejecting the SD card.

## Error messages

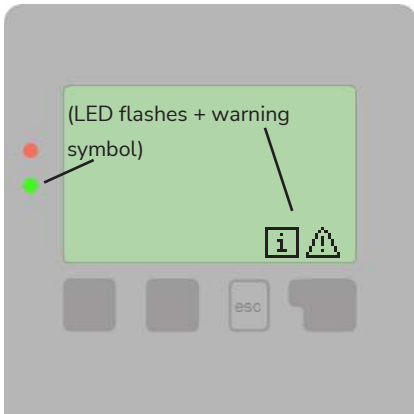

If the automatic controller recognises a malfunction, the warning symbol will appear in the display. When the error is corrected, then the warning symbol changes to an information symbol.

Further information about the error may be obtained by pressing the key under the warning or information symbol.



**Do not act on your own accord.**

**Ask a specialist for advice in the event of problems!**

Possible error messages	Notes for the specialist
Sensor error	Either the sensor, sensor entry on the automatic controller or the connection cable is/was defective.
Restart	Means that the automatic controller was restarted, e.g., because of a loss of power. Check the date and time!
Time and date	This display appears automatically after a lengthy loss of power because the time and date must be checked and, if necessary, reset.
Strong clocking	This is displayed if the pump switches on and off more than 5 times in 5 minutes (that is, in the event of 11 starts and stops).
No flow	Displayed if the pump is running and the $\Delta t > 50$ °C for 5 minutes.
Excessive/Insufficient system pressure	Displayed if Pmin and/or Pmax is less or more than allowed when the pressure monitor is switched on.
SD card error	Displayed when an SD card is recognised but the automatic controller cannot read it or write to it.

## Replacing a fuse



**Repair and maintenance may only be carried out by qualified persons. Disconnect the power supply before working on the device and secure against reconnection! Make sure the power is off!**



**Only use the spare fuse included, or a fuse that is constructed in an identical manner and has the following characteristics: T2 A / 250 V.**

Three fuses have been installed in the automatic controller that protect the different relays as well as the controller

electronics. If the automatic controller has no function or display when it is connected to power, or no mechanical or

electronic relays are functioning, then open the device as described under section C, below, then remove and check all fuses.

Change the defective fuse, and find and exchange any external defective parts (e.g. pump).

Finally, restart the automatic controller.

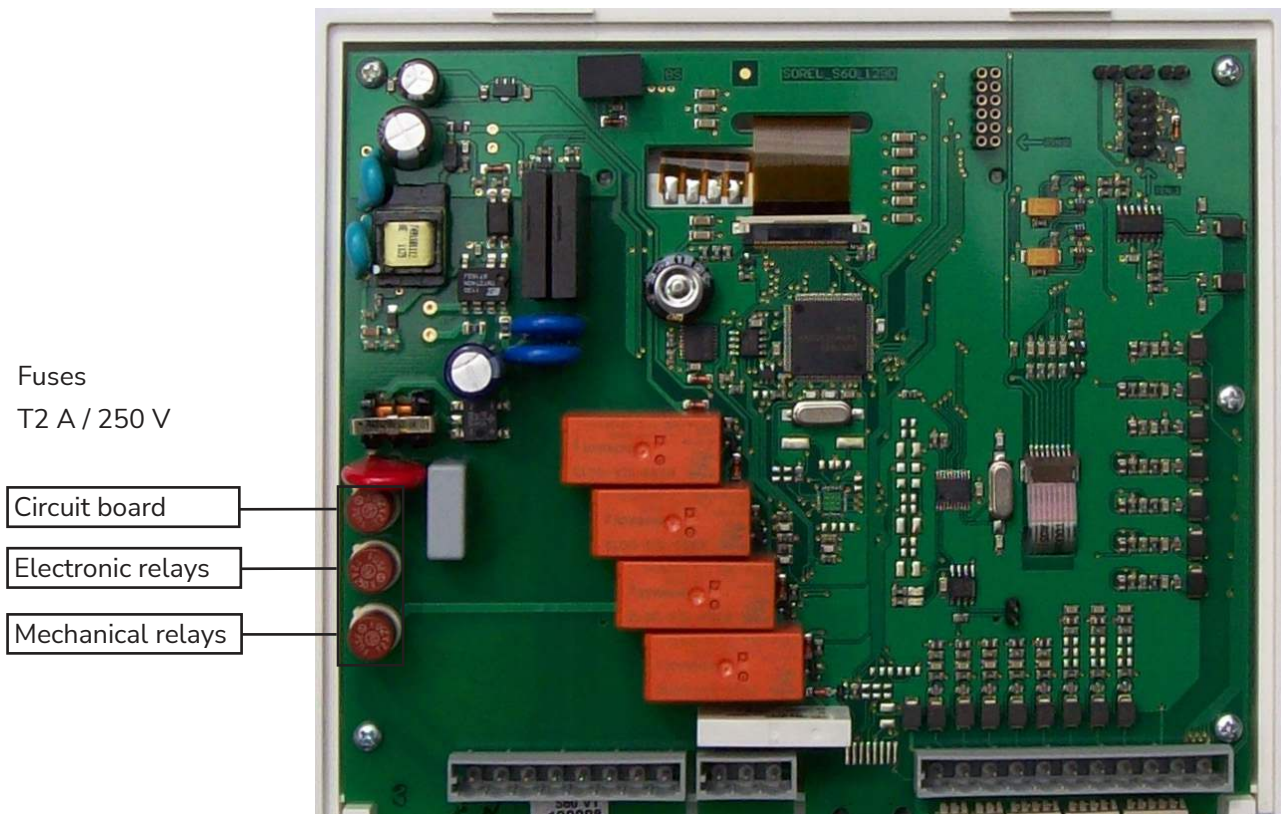

## Maintenance



In the course of the annual general servicing of your heater, you should also have the qualified person check the functions of the automatic controller and, if necessary, optimise its settings.

### Carrying out maintenance

- Checking the date and time
- Assessment/Plausibility check of the evaluations
- Managing the error log memory
- Check/Plausibility check of the current measured values
- Managing the switch outputs/loads in manual operation
- Possible optimisation of the set parameters

## Product information

### Description

The controller was produced and tested in accordance with strict quality and safety requirements. The legal warranty period of two years from the date of sale applies to the device.

However, the manufacturer shall accept no liability or warranty claims for personal injuries and damage to property resulting from one or more of the following:

- Failure to observe these mounting and operating instructions
- Incorrect mounting, setup, maintenance and operation
- Improper repairs
- Unauthorized modifications to the device
- Installation of additional components that were not tested together with the device
- All damages resulting from continued use of the device in spite of an obvious defect
- Failure to use original spare parts and accessories
- Use of the device in an unintended manner
- Failure to observe the limit values set out in the technical data
- Force majeure

### About the controller

The EHC controller makes it possible to recover the waste heat energy in your extracts air or flue gasses through it's wide range of effective functions. Managing the controller parameters are very easy using the self-explanatory menu.

The individual entry buttons have specific functions and are explained in the context of each step. In the controller menu, you will find not only keywords but also help texts and clear graphics relating to the measurements and settings.

The EHC20 can be used as a temperature differential controller for various types of systems. These are illustrated and explained from page 32 onwards.

Key features of the EHC20:

- Illuminated display showing graphics and texts
- Straightforward querying of current measurements
- Various options for evaluating and monitoring the system, e.g. graphical statistics
- Extensive settings menus with explanations
- Menu lock function to prevent accidental changes
- Reset option for restoring previous values or factory settings
- Various additional functions are available as options.

## Items supplied

- EHC20 temperature differential controller
- 3 screws (3.5 x 35 mm) and 3 plugs (6 mm) for wall mounting
- 12 strain relief clamps with 24 screws, replacement fuses 1x T2 A / 250 V
- Micro SD card
- EHC20 mounting and operating manual

Optionally supplied depending on model/order:

- Pt1000 temperature sensors and thermowells

Also available:

- Pt1000 temperature sensors, thermowells, overvoltage protection

# Controller description

## Technical data

### Electrical data:

Mains voltage	100 - 240 VAC
Mains frequency	50 - 60 Hz
Power consumption	0.5 - 3 W
Switching power	
Total electronic relay switching power:	460 VA for AC1 / 240 W for AC3
Electronic relay R1	Min. 5 W...max. 120 W for AC3
Electronic relay R2	Min. 5 W...max. 120 W for AC3
Total mechanical relay switching power:	460 VA for AC1 / 460 W for AC3
Mechanical relay R3	460 VA for AC1 / 460 W for AC3
Mechanical relay R4	460 VA for AC1 / 460 W for AC3
Mechanical relay R5	460 VA for AC1 / 460 W for AC3
Mechanical relay R6	460 VA for AC1 / 460 W for AC3
Potential-free relay R7	460 VA for AC1 / 185 W for AC3
0..10V output	Designed for 10 kΩ load resistance
PWM output	Freq. 1 kHz, level 10 V
Internal fuse	2A slow-blow 250 V (3x)
Protection type IP40	
Protection class	II
Overvoltage category	II
Pollution level	II
Sensor inputs	8 x Pt1000 2 x Grundfos direct sensors 1 x RC21
Measuring range	
PT1000	-40°C to 300°C
Grundfos direct sensor:	0°C - 100°C (-25°C / 120°C briefly)
VFS 1 l/min - 12 l/min (VFS1-12)	RPS 0 - 0.6 bar
2 l/min - 40 l/min (VFS2-40)	0 - 1 bar
5 l/min - 100 l/min (VFS5-100)	0 - 1.6 bar
10 l/min - 200 l/min (VFS10-200)	0 - 2.5 bar
	0 - 4 bar
	0 - 6 bar
	0 - 10 bar

**Permitted total cable lengths:**

Sensors S7 and S8	<30 m
Other Pt1000 sensors	<10 m
VFS/RPS sensors	<3 m
CAN	<3 m
PWM/ 0...10 V	<3 m
Electronic relay	<3 m
Mechanical relay	<10 m

**Storage medium**

Micro SD card slot

**Real time clock**

RTC with 24-hour power backup

**Permitted ambient conditions:**

## Ambient temperature

during controller operation 0°C...40°C

during transport/storage 0°C...60°C

## Air humidity

during controller operation Max. 85% rel. humidity at 25°C

during transport/storage No condensation allowed

**Other data and dimensions**

## Housing design

Three-part, ABS plastic

## Installation options

Wall mounting, switch panel mounting (optional)

## Overall dimensions

228 x 180 x 53 mm

## Display

Fully graphical display, 128 x 128 dots

## LEDs

2; 1 x red, 1 x green

## Operation

4 entry buttons

# Operation

## Display and entry system

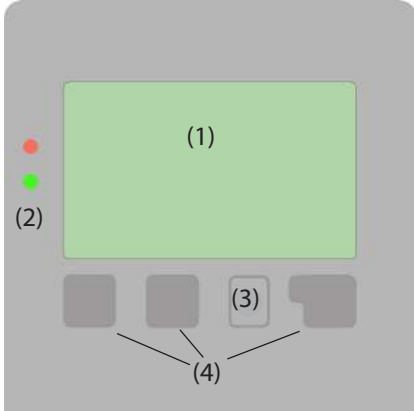





The display (1) with an extensive text and graphics mode makes the controller virtually self-explanatory in use.

To access the settings from the overview, press the "esc" button.

The green status LED (2) lights up as soon as a relay is connected; the red LED flashes in the event of an error message.

Entries are made using four buttons (3+4) which perform different functions depending on the situation. The "esc" button (3) is used to cancel an entry or exit a menu.

Example display symbols:

-  Pump (rotates when operating)
-  Valve (direction of flow in black)
-  Storage tank
-  Temperature sensor
-  Heat exchanger
-  Filling delay (see Filling time)
-  Warning / error message
-  New information
-  Logging enabled

Further symbols are used for the special functions

You may then be prompted to confirm that you wish to save your changes.

The functions of the other three buttons (4) are explained in the area of the display directly above the buttons. Generally speaking, however, the right-hand button is used to make and confirm selections.

Example button functions:

- |         |                              |
|---------|------------------------------|
| +/-     | = Increase / decrease values |
| ▼/▲     | = Scroll down / up in a menu |
| Yes/No  | = Confirm / cancel           |
| Info    | = Further information        |
| Back    | = Return to previous display |
| OK      | = Confirm selection          |
| Confirm | = Confirm setting            |



## Setup wizard

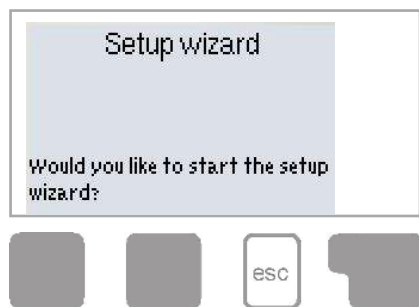

After switching the controller on for the first time and setting the language and time, you will be asked whether or not you would like to parametrise the controller with the help of the setup wizard. However, the setup wizard can be closed or launched again later on from the Special functions menu. The setup wizard guides you through the necessary basic settings in the correct order and provides brief descriptions of the various parameters in the display. Pressing the "esc" button takes you back to the previous value so that you can view the selected setting again and adjust it if necessary. Pressing the "esc" button more than once takes you back

step by step to the selection mode, thus cancelling the setup wizard. You should now select "Manual" in the Operating mode menu (page 37) in order to test the switch output with the load connected and check if the values for the sensors are correct. You can then switch to automatic operation.

**Observe the explanations of the individual parameters on the following pages, and check whether further settings are necessary for your application.**

## Unassisted setup

If you decide not to use the setup wizard, you should make the necessary settings in the following order:

- Menu 9. Language, page 59
- Menu 6.11 Time and date, page 57
- Menu 6.1 Program selection, page 41
- Menu 4. Settings, all values, page 37
- Menu 5. Protective functions, if changes needed, page 39
- Menu 6. Special functions, if further changes needed. page 41

You should now select "Manual" in the Operating mode menu, page 37 in order to test the switch outputs with the load connected and check if the values for the sensors are correct. You can then switch to automatic operation.

**Observe the explanations of the individual parameters on the following pages, and check whether further settings are necessary for your application.**

**Exodraft recommends that you save the configuration on the SD card after the setup.**

To save the configuration, you will need to use the "Save config." function. This can be found in Menu 6.14 (Special functions/SD card).

## Menu sequence and structure

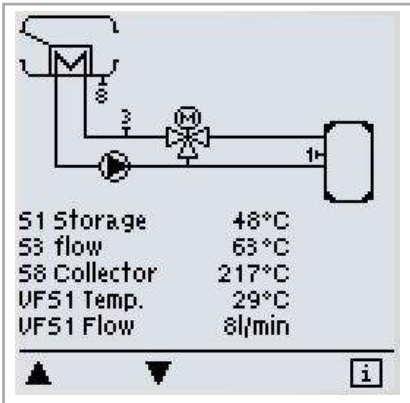

The graphics or overview mode appears when no button has been pressed for two minutes or if the main menu is exited by pressing "esc".

Within this overview, you can scroll through the sensors and relays using the up and down buttons.

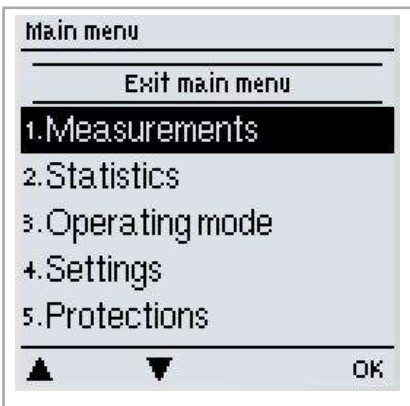

In graphics or overview mode, the esc button takes you straight to the main menu. The following items are then available to choose from:

1. Measurements	Current temperature values with explanations
2. Statistics	System function check with operating hours etc.
3. Operating mode	Automatic operation, manual operation or switch off device
4. Settings	Set parameters required for normal operation
5. Protections	Return cooling, anti-seize protection
6. Special functions	Program selection, sensor calibration, clock, additional sensors etc.
7. Menu lock	Prevents accidental changes at critical points
8. Service data	For diagnostics in the event of an error
9. Language	Select language

# 1. Measurements

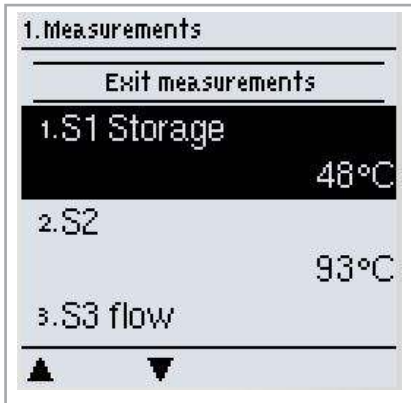

The menu "1. Measurements" is displaying the currently measured temperature values.

The menu can be exited by pressing "esc" or selecting "Exit measurements".



If "--" appears in the display instead of the measurement, this indicates a defective or incorrect temperature sensor. If the cables are too long or the sensors are not positioned optimally, this can result in minor deviations in the measurements. In this case, the display values can be corrected by entering the relevant information into the controller. Follow the instructions under page 56. What measurements are displayed depends on the selected program, the sensors connected and the specific device design.

## 2. Statistics



The "2. Statistics" menu is used for function control and long-term monitoring of the system.

The menu can be exited by pressing "esc" or selecting "Exit statistics".



In order to evaluate system data, the controller clock must be set correctly. Improper operation or an incorrect time may result in data being deleted, recorded incorrectly or overwritten. The manufacturer accepts no liability for the data recorded.

### 2.1 Operating hours

Shows the running hours of the circulation pump connected to the controller. Various time ranges (day-years) are available.

### 2.2 Heat quantity

Shows the system's heat yield.

### 2.3 Graphic overview

The data set out under 2.1-2.2 are presented clearly in the form of a bar chart here. Various time ranges are available for comparison. You can scroll using the two buttons on the left.

### 2.4 Reports

Shows the last 20 system reports issued along with details of the date and time.

### 2.5 Reset / delete

Allows you to reset and delete individual statistics. If you select "All statistics", everything apart from the error list will be deleted.

## 3. Operating mode

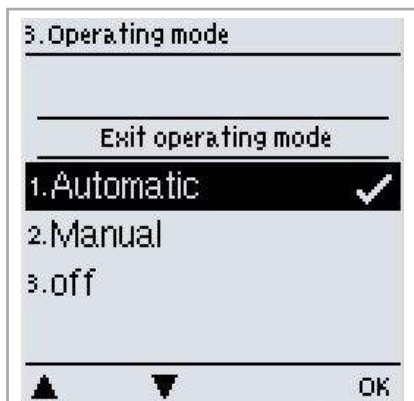

In the "3. Operating mode" menu, you can not only select the automatic mode but also switch off the controller or switch to a manual operating mode.

You can exit the menu by pressing "esc" or selecting "Exit Operating mode".

### 3.1 Automatic

Automatic mode is the normal mode of operation for the controller. Only in automatic mode can the controller function correctly, taking into account the current temperatures and the parameters set. If the power supply is interrupted, the controller will automatically return to the last selected operating mode.

### 3.2 Manual

The relay and therefore the loads connected are switched on or off at the push of a button, without taking into account the current temperatures and the parameters set. The temperatures measured are displayed for overview and function control purposes.



If the "Manual" operating mode is selected, the current temperatures and parameters selected no longer play any role. There is therefore a risk of scalding or serious damage to the system. The "Manual" operating mode should only be used by specialists for brief function tests or when setting up the controller.

### 3.3 Off



If the "Off" operating mode is enabled, all controller functions are switched off. This can cause the solar collector or other system components to overheat. The temperatures measured continue to be displayed for overview purposes.



This section is only applied if the heatrecovery is used without bypass damper.

This can cause the heat recovery unit to overheat. The measured temperatures are still being displayed on the screen in the mode "Off"

## 4. Settings

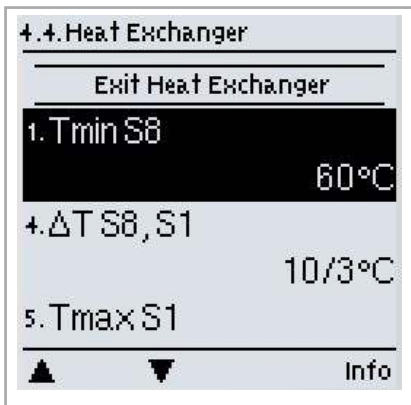

In the "4. Settings" menu, you can configure the basic settings for the control functions.



Under no circumstances are these settings designed as a substitute for the customer's own safety provisions!

You can exit the menu by pressing "esc" or selecting "Exit settings".



The menu numbering varies depending on the hydraulic schema chosen (see "6.1 Program selection", page 41)

### 4.1 Tmin S (X)

Enable/switch-on temperature at sensor X

If this value is exceeded at the specified sensor and the other conditions are met, the controller will switch on the associated pump or valve. If the temperature at the sensor then drops 5°C below this value, the pump or valve will be switched off again.

Setting range: 0°C to 99°C / default: 20°C

### 4.2 Tmax S (X)

Switch-off temperature at sensor X

If the Tmax value at the selected temperature probe is exceeded the bypass damper will change position to bypass. The bypass mode is maintained until the measured temperature are beneath the Tmax setpoint again, and the other conditions for the system, to enter heat production are met again. The bypass damper will change position into heat production.

Setting range: 0°C to 99°C / default: 60°C



Excessively high temperature settings can result in scalding or damage to the system. The customer must make provisions to prevent scalding.

### 4.3 Priority S(X)

#### Priority of the storage tank X

This setting specifies the filling order. If an equal priority is set, the storage tanks will be filled on an equal basis.

Setting range: 1-4

### 4.4 T priority

#### Temperature threshold for absolute priority during primary filling

In multiple storage tank systems, the filling of a lower-ranking storage tank will not commence until the temperature setpoint at the sensor for the higher-ranking storage tank is exceeded.

Setting range: 0°C to 90°C / default: 40°C

## 4.5 Filling time



### **Interrupting the filling of a lower-ranking storage tank**

When using a program with more than one storage tank it's possible to prioritize between the storage tanks. When the Tsetpoint for the higher ranking tank is reached, the controller will switch to fill the lower ranking tank. When the minimum filling time has been reached filling the lower ranking storage tank, the controller will switch back to filling the higher ranking storage tank, if the temperature in the tank is lower than the temperature set in the 4.4 T priority.

*Setting range: 1 to 90 minutes / default: 20 minutes*

## 4.6 Temperature rise

### **Extending the filling delay due to temperature rise**

In order to set the exact filling priorities for systems with multiple storage tanks, the minimum temperature rise at the collector (measured over a minute) which is needed in order for the delay in filling the lower-ranking storage tank to be extended by a minute is set. The delay is extended because the temperature rise at the collector will presumably soon allow the higher-ranking storage tank to be filled. The filling of the primary storage tank will begin as soon as  $\Delta T$  switch-on conditions are met. If, however, the temperature rise undershoots the set value, the filling of the lower-ranking storage tank will once again be enabled.

*Setting range: 1°C to 10°C / default: 3°C*

## 5. Protective functions

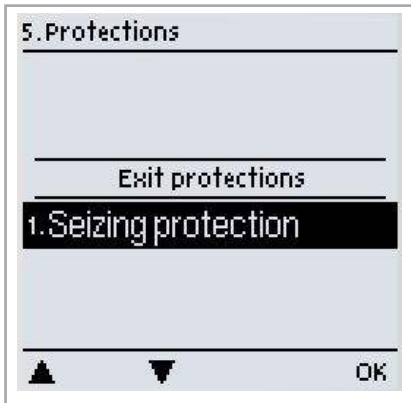

In the "5. Protective functions" menu, you can enable and configure various protective functions.



**Under no circumstances are these settings designed as a substitute for the customer's own safety provisions!**

You can exit the menu by pressing "esc" or selecting "Exit protective functions".

### 5.1 Anti-seize protection

If anti-seize protection is enabled, the controller will switch on the relevant relay and the connected load for 5 seconds every day at 12 o' clock or every Sunday at 12 o' clock in order to prevent the pump or the valve seizing as a result of extended standstill periods.

*R1 setting range: daily, weekly, off / default: Off*

*R2 setting range: daily, weekly, off / default: Off*



## 6. Special functions



In the "6. Special functions" menu, basic settings and advanced functions can be configured.



Under no circumstances are these settings designed as a substitute for the customer's own safety provisions!

You can exit the menu by pressing "esc" or selecting "Exit special functions".



The menu numbering varies depending on the hydraulic schema chosen (see "6.1 Program selection", page 41)

### 6.1 Program selection

You can select and set the appropriate hydraulic variant for your particular application here (see Hydraulic variants / overview / systems 32).

Setting range: 1-48 / default: 1



Under normal circumstances, the program is selected once only when the specialist is setting up the controller. If an incorrect program is selected, this may lead to unexpected malfunctions.

### 6.2 Rotational speed control

If rotational speed control is enabled, a special internal electronic system in the EHC20 allows you to alter the rotational speed of pumps according to process requirements.



It is not recommended to use the pump speed control due to that the heat exchanger must always have a large waterflow through the cassettes to avoid overheating.

#### 6.2.1 Rotational speed modes

The following rotational speed modes are available:

**Off:** There is no rotational speed control. The pump connected is switched on at full speed or switched off.

**Mode 1:** The controller switches to the set max. rotational speed after the purging period. If the temperature difference  $\Delta T$  between the reference sensors (collector and storage tank) is below the set switch-on temperature difference  $\Delta T R1$ , the rotational speed will be reduced.

If the temperature difference between the reference sensors is above the set switch-on temperature difference  $\Delta T R1$ , the rotational speed will be increased. If the controller has adjusted the rotational speed of the pump down to the lowest level and the  $\Delta T$  between the reference sensors is  $\Delta T_{off}$ , the pump is switched off.

**Mode 2:** The controller switches to the set min. rotational speed after the purging period. If the temperature difference  $\Delta T$  between the reference sensors (collector and storage tank) is above the set switch-on temperature difference  $\Delta T R1$ , the rotational speed will be increased.

If the temperature difference  $\Delta T$  between the reference sensors is below the set switch-on temperature difference  $\Delta T R1$ , the rotational speed will be reduced.

If the controller has adjusted the rotational speed of the pump down to the lowest level and the  $\Delta T$  between the reference sensors is  $\Delta T_{off}$ , the pump is switched off.

**Mode 3:** The controller switches to the set min. rotational speed after the purging period. If the temperature at the reference sensor (collector; in systems with heat exchanger for relay 2 the heat exchanger) is above the setpoint value to be set subsequently, the rotational speed will be increased.

If the temperature at the reference sensor is below the setpoint value to be set subsequently, the rotational speed will be reduced.

**Mode 4** (2 storage tank system)

If the valve is set towards the higher-ranking storage tank, the rotational speed will be regulated as in M3. If the valve is set towards the lower-ranking storage tank, the rotational speed will be regulated as in M2.

*Setting range: M1, M2, M3, M4, off / default: off*

## 6.2.2 Pump type

The type of speed-controlled pump should be set here.

Standard: Rotational speed control via wave packet control for standard pumps.

0-10 V: Control system for special pumps (e.g. high-efficiency pumps) using a 0-10 V signal.

PWM: Control system for special pumps (e.g. high-efficiency pumps) using a PWM signal.

## 6.2.3 Pump settings

In this menu, you can configure the settings for the 0-10 V or PWM pump.



If you select this menu, you may be prompted to save the rotational speed settings.

### 6.2.3.1 Pump

In this menu, you can select preset profiles for the pump or configure all settings yourself under "Manual". The settings can also be changed after selecting a profile.

### 6.2.3.2 Signal form

In this menu, you can set the type of pump: Heating pumps are designed to set maximum power with a small input signal, while solar pumps provide low power from a small input signal. Solar = normal, heating = inverted.

*Setting range: Normal, inverted / default: Normal*

### 6.2.3.3 PWM off

This signal is output when the pump is switched off (pumps with cable breakage detection require a minimal signal).

*Setting range: (Solar:) 0 to 50% / default: 0% - (Heating:) 50% to 100% / default: 100%*

### 6.2.3.4 PWM on

The pump needs this signal in order to switch on and run at minimum speed.

*Setting range: (Solar:) 0 to 50% / default: 10% - (Heating:) 50% to 100% / default: 90%*

### 6.2.3.5 PWM max

With this value, you can specify the maximum frequency for the highest speed of an energy-saving pump which will be used during purging or manual operation for example.

*Setting range: (Solar:) 50 to 100% / default: 100% - (Heating:) 0% to 50% / default: 0%*

### 6.2.3.6 0-10V off

This voltage is output when the pump is switched off (pumps with cable breakage detection require a minimum voltage).

Setting range: (Solar;) 0.0 to 5.0 V / default: 1.0 V - (Heating;) 5.0 to 0.0 V / default: 4.0 V

### 6.2.3.7 0-10V on

The pump needs this voltage in order to switch on.

Setting range: (Solar;) 0.0 to 5.0 V / default: 1.0 V - (Heating;) 5.0 to 10.0 V / default: 9.0 V

### 6.2.3.8 0-10V max

With this value, you can specify the maximum voltage level for the highest speed of an energy-saving pump which will be used during purging or manual operation for example.

Setting range: (Solar;) 5.0 to 10.0 V / default: 10.0 V - (Heating;) 0.0 to 5.0 V / default: 0.0 V

### 6.2.3.9 Rotational speed when "On"

In this menu, you can change the basis for calculating the rotational speed shown. If, for example, 30% is specified here, 30% rotational speed will be shown when applying the frequency/voltage under "PWM On" / "0-10 V On". If the frequency/voltage for "PWM Max" / "0-10 V Max" is applied, 100% rotational speed will be shown. Intermediate values will be calculated accordingly.

Setting range: 10 to 90% / default: 30%



This function does not influence control functions. It merely influences the display on the status screen.

### 6.2.3.10 Show signal

Shows the pump signal set in a graphical and text overview.

#### 6.2.3a Example pump settings

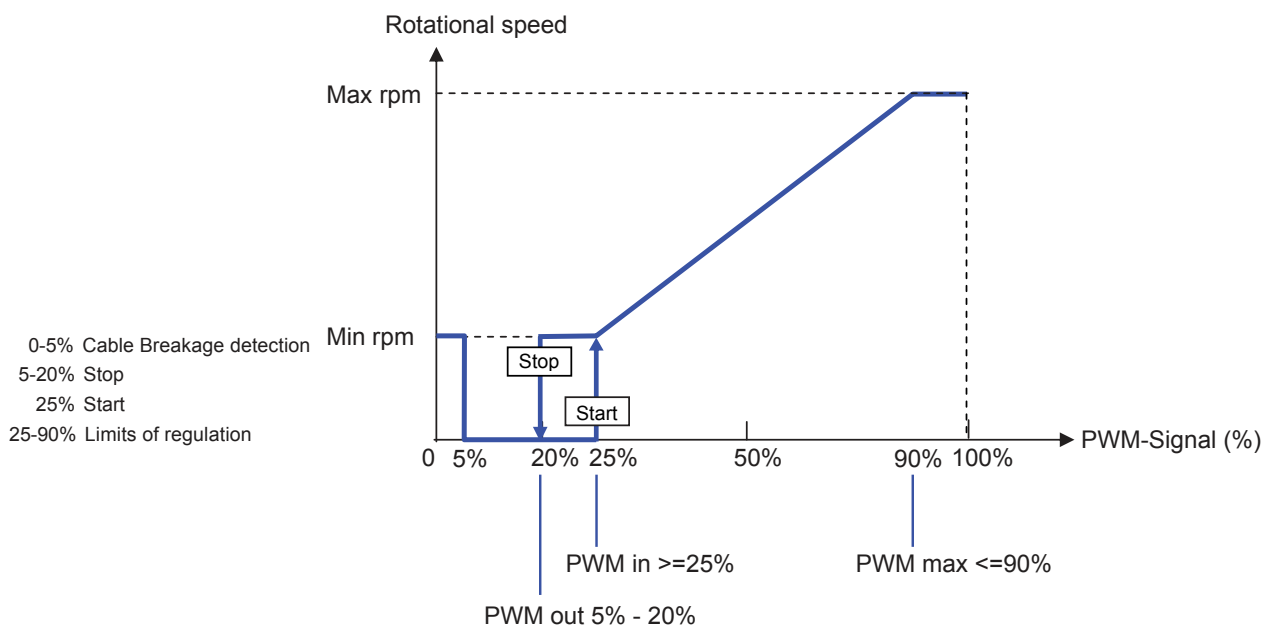

### 6.2.3b Technical data – PWM and 0-10 V

#### PWM technical data:

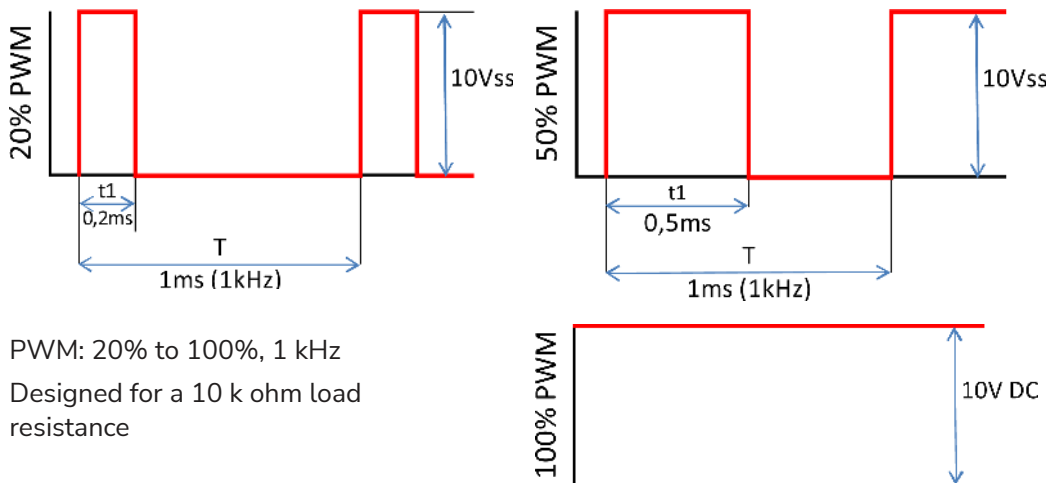

PWM: 20% to 100%, 1 kHz  
 Designed for a 10 k ohm load  
 resistance

#### 0-10 V technical data:

0-10 V: 2 V to 10 V (20% to 100%)  
 Designed for a 10 k ohm load resistance.

10 V = 100% rotational speed  
 5 V = 50% rotational speed  
 2 V = 20% rotational speed  
 0 V = Off

### 6.2.4 Purging time

During this time, the pump runs at full speed (100%) in order to ensure a reliable start-up. Only after this purging time will the pump run at a controlled speed and switch to the max. or min. speed depending on the mode set.

The purging time cannot be used with 0-10 V / PWM pumps.

Setting range: 5 to 600 seconds / default: 8 seconds

### 6.2.5 Control time

The control time is used to determine the latency of rotational speed control in order to minimise temperature fluctuations. The time span required for a complete control cycle from minimum to maximum speed is specified here.

Setting range: 1 to 15 minutes / default: 4 minutes

### 6.2.6 Max. rotational speed

The maximum rotational speed of the pump is specified here. During the setting procedure, the pump runs at the relevant speed and the throughflow can be determined.

Setting range: 70% to 100% / default: 100%



If you select this menu, you may be prompted to save the rotational speed settings.

### 6.2.7 Min. rotational speed

The minimum rotational speed of the pump is specified here. During the setting procedure, the pump runs at the relevant speed and the throughflow can be determined.

Setting range: ("6.2.3.9 Rotational speed when "On", page 43) to max. rotational speed -5% / default: 30%



The percentages are guide values that may vary to a greater or lesser extent depending on the system, pump and pumping level. 100% is the maximum possible controller voltage/frequency.

### 6.2.8 Setpoint value

This value is the control setpoint value for Mode 3 (see "6.2.1 Rotational speed modes", page 41). If this value at the sensor drops below, the rotational speed will be reduced. If it is exceeded, the rotational speed will be increased.

*Setting range: 0°C to 90°C / default: 60°C*

## 6.3 R2 rotational speed control

R2 rotational speed control - see "6.2 Rotational speed control", page 41

## 6.4 Relay functions

Free relays, i.e. relays not used in the basic schema, can be assigned the additional functions explained here. Each additional function can be used only once.

R1 and R2: ELRs / electronically speed-controlled relays

R3 to R6: Mechanical relays 230 V

R7: Potential-free relay

V1 and V2: PWM and 0-10 V outputs

Please note the technical information for the relays (see page 30).

The symbols shown will be displayed on the overview screen as soon as you enable the function.

The numbering in this list does not correspond to the numbering in the controller menu.



### 6.4.1 Thermostat

When using the controller for heat recovery control the thermostat function should not be used.

*Setting range: On, Off*



Excessively high temperature settings can result in scalding or damage to the system.

The customer must make provisions to prevent scalding.

In economy mode, other values, e.g. T eco may apply.

#### 6.4.1.1 TH setpoint

The target temperature at thermostat sensor 1. Below this temperature, the heating will switch on until TH setpoint+hysteresis is reached.

*Setting range: -20 - 99°C / default: 50°C*

#### 6.4.1.2 TH hysteresis

Hysteresis of the setpoint value.

*Setting range: 1 - 50°C / default: 10°C*

#### 6.4.1.3 Thermostat sensor 1

Tsetpoint is measured at thermostat sensor 1

If thermostat sensor 2 is connected, the relay will switch on when the temperature drops below "TH setpoint" at thermostat sensor 1, and off when "TH setpoint" + hysteresis at thermostat sensor 2 is exceeded.

*Setting range: S1-S8, VFS1-2, Active storage tank / default: none*

#### 6.4.1.4 Thermostat sensor 2

Optional switch-off sensor

If "TH setpoint" + hysteresis at thermostat sensor 2 is exceeded, the relay will be switched off.

*Setting range: S1-S8, VFS1-2, Active storage tank / default: none*

#### 6.4.1.5 T eco

Setpoint value in economy mode

When in economy mode: During solar charging, the "T eco" value will be used instead of "TH setpoint" as the setpoint value. As soon as the temperature at thermostat sensor 1 drops below "T eco", the relay will be switched on and will heat until "T eco" + hysteresis is reached.

*Setting range: 0 - 99°C / default: 40°C*

#### 6.4.1.6 Storage tank

Economy mode

Charging the storage tank selected here will enable the economy mode.

If this storage tank is currently being run using solar, the heating will only be switched on if the temperature is below "T eco".

*Setting range: (Storage tank sensor) / default: First storage tank*

#### 6.4.1.7 Economy mode

In economy mode, the heating will only switch on when the temperature drops below the "T eco"-setting, and will heat to "T eco" + hysteresis if solar charging is enabled.

*Setting range: On, Off / default: Off*

#### 6.4.1.8 Times

Enable time for the thermostat function

You can set the desired time periods during which the thermostat function is enabled from a time point of view here. You can enter three times for each day of the week. You can also copy individual days to other days. The thermostat function is switched off outside the set times.

*Setting range: 00:00 to 23:59 / default: 06:00 to 22:00*

### 6.4.2 Thermostat 2

When using the controller for heat recovery control the thermostat function should not be used.

---

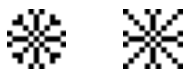

### 6.4.3 Cooling

When using the controller for heat recovery control the cooling function should not be used.

*Setting range: On, Off*

#### 6.4.3.1 Co Tsetpoint

The target temperature at thermostat sensor 1. Above this temperature, cooling will be switched on until Co Tsetpoint + hysteresis is reached.

*Setting range: 0 - 99°C / default: 50°C*

#### 6.4.3.2 Co hysteresis

If the temperature at the cooling sensor undershoots Tsetpoint + hysteresis, the relay will be switched off.

*Setting range: -50°C to -1°C / default: -10°C*

#### 6.4.3.3 Cooling sensor

The reference sensor for the cooling function.

*Setting range: S1-S8, VFS1-2, Active storage tank, RC / default: none*

#### 6.4.3.4 Times

Enable time for the cooling function

You can set the desired time periods during which the cooling function is enabled from a time point of view here. You can enter three times for each day of the week. You can also copy individual days to other days. The cooling function is switched off outside the set times.

*Setting range: 00:00 to 23:59 / default: 06:00 to 22:00*



### 6.4.4 Return flow temperature rise

With this function, the return flow temperature of a heating circuit can be increased with the help of the storage tank.

*Setting range: On, Off*

#### 6.4.4.1 RF Tmax

Maximum temperature at the storage tank sensor. If this temperature at the set storage tank sensor is exceeded, the relay will be switched off again.

*Setting range: 0 - 99°C / default: 70°C*

#### 6.4.4.2 $\Delta T$ return flow

Switch-on temperature difference

If the temperature difference between the storage tank sensor and the return flow sensor is exceeded, the relay will be switched on.

*Setting range: 5-20 K / default: 8 K*

Switch-off temperature difference:

If the temperature difference between the storage tank sensor and the return flow sensor is exceeded, the relay will be switched off.

*Setting range: 2-19 K (limited by  $\Delta T$  storage tank RF On) / default: 4 K*

#### 6.4.4.3 Return flow sensor

Return flow sensor selection

*Setting range: S1-S8, VFS1-2, Active storage tank / default: none*

#### 6.4.4.4 Storage tank sensor

Storage tank sensor selection

*Setting range: S1-S8, VFS1-2, Active storage tank / default: none*

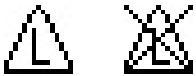

### 6.4.5 Anti-Legionella function

When using the controller for heat recovery control the anti-legionella function should not be used.

*Setting range: On, Off*

#### 6.4.5.1 AL Tsetpoint

This temperature must be reached at the AL sensor(s) for the AL action time in order to allow successful heating.

*Setting range: 60 - 99°C / default: 70°C*

#### 6.4.5.2 AL action time

The AL Tsetpoint temperature at the AL sensors must prevail for this period of time in order to allow successful heating.

*Setting range: 1-120 min / default: 15 min*

#### 6.4.5.3 Last AL heating

Details of when the last successful heating took place are shown here.

*No setting options*

#### 6.4.5.4 AL sensor 1

The temperature for the AL function is measured by this sensor.

*Setting range: S1-S8, VFS1-2, Active storage tank / default: none*



#### 6.4.5.5 AL sensor 2

##### Optional AL sensor

If this sensor is connected, Tsetpoint AL must be reached at both sensors for the action time in order to allow successful heating.

*Setting range: S1-S8, VFS1-2, Active storage tank / default: none*

#### 6.4.5.6 AL times

AL heating will take place at these times.

*Setting range: 00:00 to 23:59 / default: 06:00 to 22:00*



This anti-Legionella function does not offer complete protection against Legionella because the controller relies on a sufficient supply of energy and the temperatures cannot be monitored in the entire storage tank area and the connected pipe system. To ensure complete protection against Legionella, your energy sources must be able to heat the water to the necessary temperature, while your external control devices must ensure that the water is able to circulate within the storage tank and pipe system.

The anti-Legionella function is switched off as standard.



When the anti-Legionella function is enabled, the storage tank will be heated to above the "Tmax S2" value set, which can result in scalding and damage to the system.



#### 6.4.6 Transfer

With this function, energy can be transferred from one storage tank to another.

*Setting range: S1-S8, VFS1-2, Active storage tank / default: none*

##### 6.4.6.1 $\Delta T$ transfer

Temperature difference for energy transfer.

If the temperature difference between the sensors reaches  $\Delta T$  transfer on, the relay will be switched on. As soon as the difference drops to  $\Delta T$  transfer off, the relay will be switched off again.

*On: Setting range: 5-20°C / default: 8°C*

*Off: Setting range: 2°C to  $\Delta T$  on / default: 4°C*

##### 6.4.6.2 Tr Tmax

Setpoint temperature of the destination storage tank

If this temperature is measured at the sensor in the destination storage tank, the transfer function will be switched off.

*Setting range: 0-90°C / default: 60°C*

##### 6.4.6.3 Tr Tmin

Minimum temperature in the source storage tank to allow transfer

*Setting range: 0-90°C / default: 30°C*

#### 6.4.6.4 Source sensor

In this menu, you can set the sensor that is positioned in the storage tank from which energy is withdrawn.

*Setting range: S1-S8, VFS1-2, Active storage tank / default: none*

#### 6.4.6.5 Destination sensor

In this menu, you can set the sensor that is positioned in the storage tank to which energy is transferred.

*Setting range: S1-S8, VFS1-2, Active storage tank / default: none*



### 6.4.7 Difference

When using the controller for heat recovery control the difference function should not be used.

*Setting range: On, Off*

#### 6.4.7.1 $\Delta T$ difference

Switch-on difference

The relay will switch on when this temperature difference is reached.

*Setting range: 3-50°C / default: 10°C*

Switch-off difference

The relay will switch off when this temperature difference is reached.

*Setting range: 2-49°C / default: 4 (the upper limit of the setting range is governed by the switch-on difference)*

#### 6.4.7.2 Source sensor

Heat source sensor/heat supplier for differential function

Sets the heat source sensor.

*Setting range: S1-S8, VFS1-2, Active storage tank / default: none*

#### 6.4.7.3 Diff Tmin

Minimum temperature at the source sensor to activate the differential relay

If the temperature at the source sensor is below this value, the difference function will not be switched on.

*Setting range: 0 to 90°C / default: 20°C*

#### 6.4.7.4 Destination sensor

Heat sink sensor/heat outlet for the differential function

Sets the heat outlet sensor.

*Setting range: S1-S8, VFS1-2, Active storage tank / default: none*

#### 6.4.7.5 Diff Tmax

Maximum temperature at the destination sensor to activate the differential relay

If the temperature at the destination sensor is above this value, the difference function will not be switched on.

*Setting range: 0 to 99°C / default: 60°C*



### 6.4.8 Solid fuel boiler

When using the controller for heat recovery control the solid fuel boiler function should not be used.

*Setting range: On, Off*

#### 6.4.8.1 SF Tmin

Minimum temperature in the boiler for switching on the pump. If the temperature at the boiler sensor is below this temperature, the relay will not be switched on.

*Setting range: 0°C to 99°C / default: 70°C*

#### 6.4.8.2 SF Tmax

Maximum temperature in the storage tank. If this is exceeded, the relay will be switched off.

*Setting range: Off up to 100°C / default: 70°C*

#### 6.4.8.3 ΔT SF

The temperature difference between the boiler and storage tank as a switch-on and switch-off condition.

Switch-on temperature difference Δ T SF

*Setting range: 5 to 20 K / default: 8*

Switch-off temperature difference Δ T SF

*Setting range: 0°C up to switch-on Δ T SF / default: 4*

#### 6.4.8.4 Boiler sensor

The sensor that is used as a boiler sensor.

*Setting range: S1-S8, VFS1-2, Active storage tank / default: none*

#### 6.4.8.5 Storage tank sensor

The sensor that is used as a storage tank sensor.

*Setting range: S1-S8, VFS1-2, Active storage tank / default: none*



### 6.4.9 Error messages

The relay will be switched on if one or more of the set conditions become active.

This function can also be inverted so that the relay is switched on all the time (Permanently on) and then switched off when a protective function becomes active.

*Setting range: On, Inverted, Off / default: Off*

*Collector alarm*

*Collector protection*

*System protection*

*Frost protection*

*Return cooling*

*Anti-Legionella function*

*Reports*



## 6.4.10 Pressure control

The relay switches on if the pressure drops below a minimum or exceeds a maximum.

*Setting range: On, Off / default: Off*

### 6.4.10.1 Pressure control

In this menu, you can enable system pressure control via a direct sensor. As soon as the set pressure conditions are exceeded, the set relay will switch on.

### 6.4.10.2 RPS1 / RPS2

Pressure sensor model

In this menu, you can set the type of pressure sensor used.

Please note: If, for example, VFS1 is connected, RPS1 will be hidden.

*Setting range: Off; 0-0.6 bar; 0-1 bar; 0-1.6 bar; 0-2.5 bar; 0-4 bar; 0-6 bar; 0-10 bar*

*Default: Off*

### 6.4.10.3 Pmin

Minimum pressure in the system. If this pressure drops below, the controller will issue an error message and the relay will switch (hysteresis: 0.5 bar).

*Setting range: Off; 0.0 to 10 bar*

*Default: Off*

### 6.4.10.4 Pmax

Maximum pressure in the system. If this pressure is exceeded, the controller will issue an error message and the relay will switch (hysteresis: 0.5 bar).

*Setting range: Off; 0.0 to 10 bar*

*Default: Off*



## 6.4.11 Booster pump

When using the controller for heat recovery control the booster pump function should not be used.

### 6.4.11.1 Filling time

Duration of pump operation

Determines for how long the pump should fill the system after being triggered.

*Setting range: 0 - 120 seconds / default: 30 seconds*

---



### 6.4.12 Parallel operation R (X)

The relay operates at the same time as the set relay R1 or R2.

*Setting range: On, Off*

#### 6.4.12.1 Delay

In this menu, you can specify how long after starting R1 or R2 the system waits until the relay operating in parallel starts.

*Setting range: 0 - 120 seconds / default: 30 seconds*

#### 6.4.12.2 Follow-up time

In this menu, you can specify how long the relay operating in parallel continues to run after R1 or R2 switches off.

*Setting range: 0 - 120 seconds / default: 30 seconds*

### 6.4.13 Parallel operation R2

See "6.4.12 Parallel operation R (X)", page 53



### 6.4.14 Permanently on

The relay is always switched on.

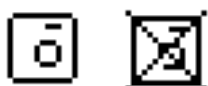

### 6.4.15 Heating circuit

When using the controller for heat recovery control the heating circuit function should not be used.

*Setting range: On, Off*

#### 6.4.15.1 Room setpoint day

Room setpoint temperature during daytime operation. If this temperature at the room sensor is exceeded within the set times, the relay will switch off.

*Setting range: 10 to 30°C / default: 20°C*

#### 6.4.15.2 Room setpoint night

Room setpoint temperature during night-time operation. If this temperature at the room sensor is exceeded outside the set times, the relay will switch off.

*Setting range: 10 to 30°C / default: 16°C*

### 6.4.15.3 Room sensor

Allows you to select the reference sensor for the room temperature.

*Setting range: S1-S8, VFS1-2, Active storage tank / default: none*

### 6.4.15.4 Times

Daytime operating times for the heating circuit function

You can set the desired time periods during which the heating circuit operates in daytime mode here. You can enter three times for each day of the week. You can also copy individual days to other days. The heating circuit operates in night-time mode outside the set times.

*Setting range: 00:00 to 23:59 / default: 06:00 to 22:00*

## 6.5 Heat quantity

### 1. Constant throughflow

If "constant throughflow" is enabled for heat quantity metering purposes, the approximate heat yield will be calculated using the values for antifreeze, antifreeze concentration and system throughflow (values to be entered manually) as well as the collector and storage tank sensor values measured.

Additional information regarding the antifreeze, the antifreeze concentration and the system throughflow is required. A correction factor for heat quantity calculation can also be set using the Offset  $\Delta T$  value. Because the heat quantity calculation is based on the collector temperature and storage tank temperature, system-related deviations in the displayed collector temperature compared to the actual forward flow temperature or in the displayed storage tank temperature compared to the actual return flow temperature can occur. These deviations can be corrected using the Offset  $\Delta T$  value. Example: Displayed collector temperature 40°C, read forward flow temperature 39°C, displayed storage tank temperature 30°C, read return flow temperature 31°C means a setting of -20% (displayed  $\Delta T$  10 K, actual  $\Delta T$  8 K => -20% correction value).

**The heat quantity data in the "constant throughflow" mode are merely guide values calculated in order to check the system functions.**

### 6.5.1 Forward flow sensor (X)

In this menu, you can specify which sensor is used to measure the forward flow temperature.

*Setting range: S1-S8, VFS1-2, Active collector, Active storage tank / default: S8*

### 6.5.2 Return flow sensor

In this menu, you can specify which sensor is used to measure the return flow temperature.

*Setting range: S1-S8, VFS1-2, Active collector, Active storage tank / default: S1*

### 6.5.3 Glycol type

In this menu, you can specify the type of antifreeze used. If no antifreeze is used, please set the proportion of glycol to 0.

*Setting range: Ethylene, propylene / default: Ethylene*

### 6.5.4 Proportion of glycol

The proportion of antifreeze added to the medium in percent.

*Setting range: 0-100% / default: 45%*

### 6.5.5 Forward throughflow (X)

Nominal system throughflow

The system throughflow in litres per minute which is used as a basis for calculating the metered heat quantity.

*Setting range: 0 - 100 l/min / default: 5 l/min*

### 6.5.6 Offset $\Delta T$

Temperature difference correction factor for heat metering

Because the heat quantity calculation is based on the collector temperature and storage tank temperature, system-related deviations in the displayed collector temperature compared to the actual forward flow temperature or in the displayed storage tank temperature compared to the actual return flow temperature can occur. These deviations can be corrected using the Offset  $\Delta T$  value. Example: Displayed collector temperature 40°C, read forward flow temperature 39°C, displayed storage tank temperature 30°C, read return flow temperature 31°C means a setting of -20% (displayed  $\Delta T$  10 K, actual  $\Delta T$  8 K => -20% correction value).

*Setting range: -50 to +50% / default: 0%*

### 6.5.7 VFS (X)

In this menu you select the flow interval for the VFS flowsensor installed in the water system.

*Setting range: Off; 1-12; 1-20; 2-40; 5-100; 10-200; 20-400 / default: Off*

### 6.5.8 VFS position

In this menu, you can specify whether the direct sensor is mounted in the forward flow or the return flow.

*Setting range: Forward flow, return flow / default: Return flow*



To avoid damaging the vortex flow sensor, it is recommended that you position it only in the return flow. If, contrary to this recommendation, you do position it in the forward flow, you must observe the maximum permitted temperature! (0°C to 100°C during permanent operation and -25°C to 120°C for short periods)

### 6.5.9 Reference sensor

You can specify the sensor to be used for heat metering here.

*Setting range: S1-S8, VFS1-2, Active collector, Active storage tank / default: S1*

## 6.6 Pressure monitoring

In this menu, you can enable system pressure monitoring via a direct sensor. As soon as the set pressure conditions are exceeded, a message will be generated and the LED will flash red.

### 6.6.1 Pressure monitoring

If the pressure drops below a minimum or exceeds a maximum, a message will be displayed and the LED will flash red.

*Setting range: On, Off / default: Off*

#### 6.6.1.1 RPS1 / RPS2

Pressure sensor model

In this menu, you can set the type of pressure sensor used.

Please note: If for example VFS1 is connected, RPS1 will be hidden.

*Setting range: Off; 0-0.6 bar; 0-1 bar; 0-1.6 bar; 0-2.5 bar; 0-4 bar; 0-6 bar; 0-10 bar*

*Default: Off*

#### 6.6.1.2 Pmin

Minimum pressure in the system. If this pressure drops below, the controller will issue an error message and the red LED will flash.

*Setting range: Off; 0.0 to 10 bar*

*Default: Off*

#### 6.6.1.3 Pmax

Maximum pressure in the system. If this pressure is exceeded, the controller will issue an error message and the red LED will flash.

*Setting range: Off; 0.0 to 10 bar*

*Default: Off*

## 6.7 Sensor calibration

Deviations in the displayed temperature values, e.g. as a result of long cables or sensors not being positioned optimally, can be corrected manually here. The settings are configured individually for each sensor in steps of 0.8°C (temperature) or 0.2% of the measurement range of the VFS / RPS sensor (throughflow / pressure).

*Sensor offset per setting range: -100 ... +100 / default: 0*

**Sensor calibration only needs to be done in the case where there are identified a problem. This should only be done during commissioning. The calibration should only be done by a specialist.**

## 6.8 Setup

Once launched, the setup wizard guides you through the basic settings for the setup in the correct order and provides brief descriptions of the various parameters in the display.

Pressing the "esc" button takes you back to the previous value so that you can view the selected setting again and adjust it if necessary. Pressing the "esc" button more than once takes you back to the selection mode, thus cancelling the setup wizard. (See also "F.2 Setup wizard", page 33)

**The setup wizard should only be launched by a specialist!  
Observe the explanations of the individual parameters in this manual,  
and check if further settings are necessary for your application.**



## 6.9 Factory settings

All settings can be reset to the original factory settings.

**All controller parameters and statistics etc. will be irretrievably lost.  
The controller will then need to be set up again.**

## 6.10 SD card

Settings for the logging function with data storage on the SD card.

### 6.10.1 Logging

In this menu, you can enable the logging of sensor and relay data and adjust the settings. Various file formats are available.

*Setting range: On, Off / default: Off*

### 6.10.2 Free storage space

Shows the amount of free space available on the SD card.

### 6.10.3 Load configuration

This function allows you to load all controller settings from the SD card.



All previous controller settings will be overwritten.

### 6.10.4 Save configuration

This function allows you to save all controller settings including the service values on the SD card.

### 6.10.5 Firmware update

With this function, the firmware stored on the SD card will be transferred to the controller.



**During the firmware update, do not switch off the controller or disconnect the power as this can cause irreparable damage. Settings can be changed and/or overwritten. After the firmware update, reset the controller to the factory settings and carry out the setup procedure again.**

### 6.10.6 Eject

In order to remove the SD card with no risk of damage or data loss, you should deregister it here first.

## 6.11 Time and date

In this menu, you can set the current time and date.

**In order to evaluate system data, the controller clock must be set correctly.  
Please note that the clock does not continue running in the event of a power failure and will therefore need to be set again.**

## 6.12 Summer time

If this function is enabled, the controller will automatically switch to winter time or summer time (DST – daylight saving time).

## 6.13 Power saving mode

In power saving mode, the background lighting for the display will be switched off if no button is pressed for two minutes.

*Default: Off*

**If a message has been issued, the background lighting will not switch off until the message has been viewed by the user.**

## 6.14 Temperature unit

In this menu, you can specify which temperature unit is displayed.

*Setting range: °F or °C / default: °C*

## 7. Menu lock

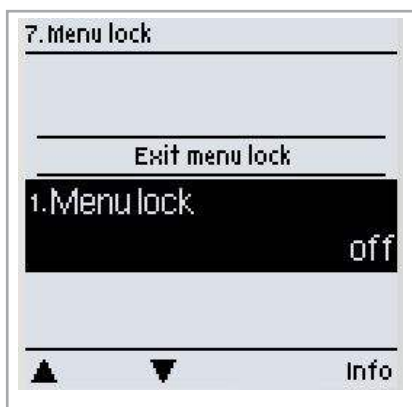

In the "7. Menu lock" menu, you can prevent the controller settings being accidentally changed.

You can exit the menu by pressing "esc".

The following menus remain fully accessible even if the menu lock is enabled and changes can be made if necessary:

1. Measurements
2. Statistics
- 6.23. Time and date
8. Menu lock
9. Service values

To lock the other menus, select "Menu lock on".

To unlock the menus again, select "Menu lock off".

*Setting range: on, off / default: off*

## 8. Service data

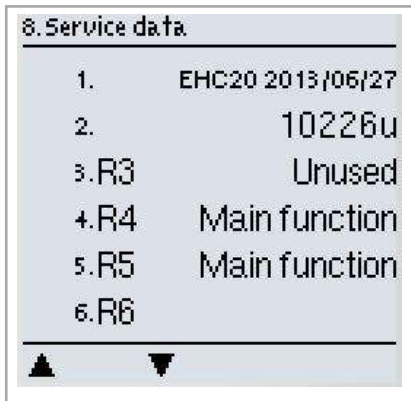

The "8. - Service data" menu can be used by a specialist or the manufacturer for remote-diagnostics etc. in the event of an error.

You can exit the menu at any time by pressing "esc".

The Service data are saved on the SD card during logging.

## 9. Language

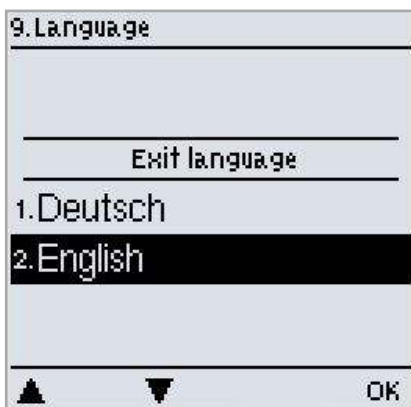

In the "9. - Language" menu, you can select the language for the menus. You will automatically be asked to select a language when the controller is used for the first time.



The languages available may vary depending on the device version!  
Not all device versions offer a choice of languages!

## Faults with error messages

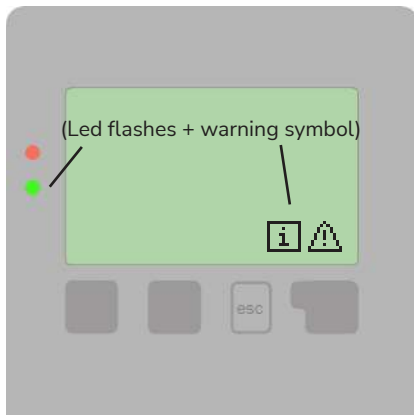

If the controller identifies a malfunction, the warning symbol will appear in the display. If the error is no longer present, the warning symbol will change to an information symbol.

Pressing the button below the warning or information symbol will bring up more detailed information regarding the error.



**Do not try to deal with problems yourself.**  
In the event of an error, please consult a specialist.

Possible error messages	Information for the specialist
Sensor fault	Either the sensor, the sensor input on the controller or the connecting lead is/was defective. (See "Temperature resistance table for Pt1000 sensors", page 62)
Restart	Indicates that the controller was restarted, e.g. owing to a power failure. Check date and time!
Time and date	This message appears automatically after an extended power failure because the time and date will need to be checked and adjusted if necessary.
Excessive cycling	This message is shown if the shunt circulation pump switches on and off again more than five times in five minutes (i.e. if 11 switching operations are recorded).
No throughflow	This message is shown if the shunt circulation pump is running and $dT \geq 50^{\circ}\text{C}$ over a five-minute period.
Excessive/insufficient system pressure	This message is displayed if the pressure monitoring function is enabled and Pmin or Pmax is exceeded.
SD card error	This message is displayed if an SD card was recognised but the controller cannot write or read data.

## Replace fuse



**Repair and maintenance work should only be carried out by specialists. Before working on the device, disconnect the power supply and ensure that the device cannot be switched on again. Check that the power is switched off.**



**Use only the spare fuses supplied or an equivalent fuse with the following rating: T2 A / 250 V.**

Three fuses are fitted to the controller. These protect the various relays as well as the electronic control system. If the controller is switched on but the functions and display are not working or the mechanical or electronic relays are not functioning, open the device as described under "Terminal plan and connections" on page 14, remove the old fuse and check it.

Replace the defective fuse, identify any defective external components (e.g. pump) and replace them too.

Switch on the controller again and check that the switch outputs are functioning in manual mode as described under "3.2 Manual", page 37.

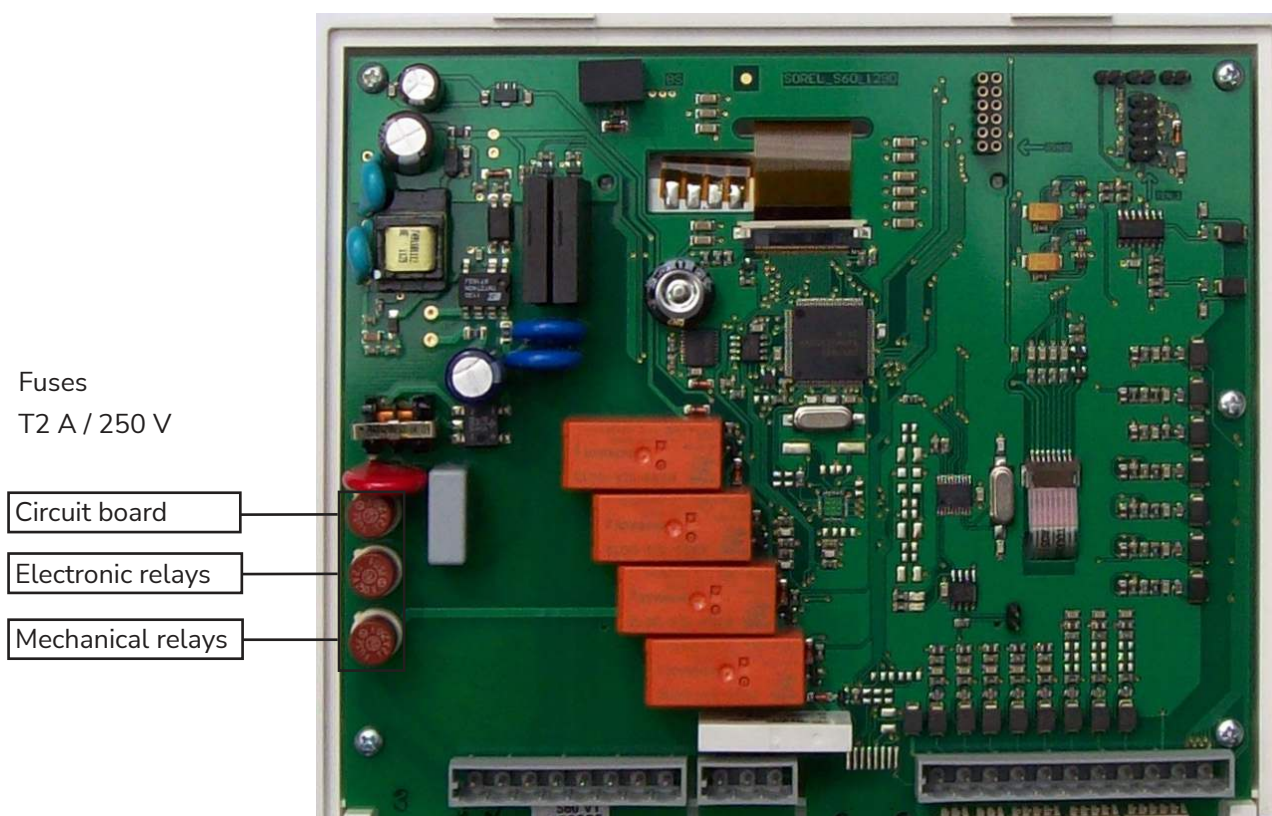

## Maintenance

As part of the general annual maintenance for your heating system, you should have the controller functions checked by a specialist and have your settings optimised if necessary.

Maintenance procedures:

- Checking the time and date (see “6.11 Time and date”, page 57)
- Assessing the statistics and carrying out a plausibility check (see “2. Statistics”, page 36)
- Checking the error memory (see “2.4 Reports”, page 36)
- Assessing the current measurements and carrying out a plausibility check (see “1. Measurements”, page 35)
- Checking the switch outputs/loads in manual mode (see “3.2 Manual”, page 37)
- If necessary, optimizing the parameters set

## Useful information / tips and tricks



Temperature resistance table for Pt1000 sensors

°C	0	10	20	30	40	50	60	70	80	90	100
Ω	1000	1039	1077	1116	1155	1194	1232	1270	1308	1347	1385



Instead of setting the system throughflow with a volume flow limiter, it is better to adjust the throughflow using the selector switch on the pump and the controller's "Max. rotational speed" setting (see "6.2.6 Max. rotational speed", page 44). This saves electricity!



The service values (see "8. Service data", page 59) include not only current measurements and operating statuses but also all controller settings. Following a successful setup, save the service values on a one-off basis ("6.10.4 Save configuration", page 57)!



In the event of queries regarding control functions or malfunctions, the service values provide a reliable and successful remote-diagnostics method. Save the service values (see "8. Service data", page 59 and "6.10.4 Save configuration", page 57) when the malfunction occurs. Send the data along with a brief description of the fault to a specialist or the manufacturer!



Log the statistics and data that are of particular importance to you (see "2. Statistics", page 36) at regular intervals in order to prevent data loss.



**UK Conformity Assessed**

---



**Exodraft a/s  
Industrivej 10  
DK-5550 Langeskov**

---

Hereby declares that the following products:

---

EHC20

---

Were manufactured in conformity with the provisions of the following regulations:

---

**The Supply of Machinery (Safety) Regulations 2008**

**Electrical Equipment (Safety) Regulations 2016**

**Electromagnetic Compatibility Regulations 2016**

---

Langeskov, 01-11-2022  
Managing Director  
*Anders Haugaard*

---



## Declaration of Conformity

DK: EU-Overensstemmelseserklæring  
GB: Declaration of Conformity  
DE: EU-Konformitätserklärung  
FR: Déclaration de conformité de l'Union Européenne  
NO: EU-Samsvarserklæring  
PL: EU Deklaracja zgodności

NL: EU-Conformiteits verklaring  
SE: EU-Överensstämmelsedeklaration  
FI: EU-Vaatimustenmukaisuusvakuutus  
IS: ESS-Samræmisstaðfesting  
IT: Dichiarazione di Conformità Unione Europea

**exodraft**

Exodraft a/s  
Industrivej 10  
DK-5550 Langeskov

Erklærer på eget ansvar, at følgende produkter:  
Hereby declares that the following products:  
Erklært hierdurch auf eigene Verantwortung, daß folgende Produkte:  
Déclare, sous sa propre responsabilité, que les produits suivants:  
Erklærer på eget ansvar at følgende produkter:  
Niniejszym oświadczam, że następujące produkty:

Veklaart dat onderstaande producten:  
Deklarerar på eget ansvar, att följande produkter:  
Vastaa siltä, että seuraava tuote:  
Staðfesti à eigin àbyrgð, að eftirfarandi vörur:  
Dichiara con la presente che i seguenti prodotti:

EHC20

Som er omfattet af denne erklæring, er i overensstemmelse med følgende standarder:  
Were manufactured in conformity with the provisions of the following standards:  
Die von dieser Erklärung umfaßt sind, den folgenden Normen:  
Auxquels s'applique cette déclaration sont en conformité avec les normes ci-contre:  
Som er omfattet av denne erklæring, er i samsvar med følgende standarder:  
Zostały wyprodukowane zgodnie z warunkami określonymi w następujących normach:

Zijn vervaardigd in overeenstemming met de voorschriften uit de hieronder genoemde normen en standaards:  
Som omfattas av denna deklaration, överensstämmer med följande standarder:  
Jota tämä selvitys koskee, on seuraavien standardien mukainen:  
Sem eru meðtalin í staðfestingu Pessari, eru í fullu samræmi við eftirtalda staðla:  
Sono stati fabbricati in conformità con le norme degli standard seguenti:

### EN 60335-1, EN 60335-2-80, DS/EN ISO 12100: 2011

I.h.t bestemmelser i direktiv:  
In accordance with  
Entsprechen gemäß den Bestimmungen der folgenden Richtlinien:  
Suivant les dispositions prévues aux directives:  
I.h.t bestemmelser i direktiv:  
Zgodnie z:

En voldoen aan de volgende richtlijnen:  
Enligt bestämmelserna i följande direktiv:  
Seuraavien direktiivien määräysten mukaan:  
Med tilvisun til ákvarðana eftirlits:  
In conformità con le direttive:

Maskindirektivet:  
The Machinery Directive:  
Richtlinie Maschinen:  
Directive Machines:  
Maskindirektivet:  
Dyrektywę maszynową:

De machinerichtlijn:  
Maskindirektivet  
Konedirektiivi:  
Vèlaeftirlitið:  
Direttiva Macchinari:

### 2006/42/EF-EEC/-EWG/-CEE

Lavspændingsdirektiv:  
The Low Voltage Directive:  
Niederspannungsrichtlinie:  
Directive Basse Tension:  
Lavspændingsdirektivet:  
Dyrektywę Niskonapięciową

De laagspanningsrichtlijn:  
Lågspänningsdirektivet:  
Pienjännitedirektiivi:  
Smáspennueftirlitið:  
Direttiva Basso Voltaggio:

### 2014/35/EC

EMC-direktivet:  
And the EMC Directive:  
EMV-Richtlinie:  
Directive Compatibilité Electromagnétique:  
EMC-direktivet:  
Dyrektywę EMC – kompatybilności elektromagnetycznej

En de EMC richtlijn:  
EMC-direktivet:  
EMC-direktiivi:  
EMC-efirlitið:  
Direttiva Compatibilità Elettromagnetica:

### 2014/30/EC

Langeskov, 01-11-2022  
Adm. direktør  
Managing Director  
Anders Haugaard

Algemeen directeur  
Geschäftsführender Direktor  
Président Directeur Général  
Verkställande direktör  
Toimitusjohtaja  
Frankvemdastjóri  
Direttore Generale









## **DK: Exodraft a/s**

Industrivej 10  
DK-5550 Langeskov  
Tel: +45 7010 2234  
Fax: +45 7010 2235  
info@exodraft.dk  
www.exodraft.dk

## **SE: Exodraft a/s**

Kalendevägen 2  
SE-302 39 Halmstad  
Tel: +46 (0)8-5000 1520  
info@exodraft.se  
www.exodraft.se

## **NO: Exodraft a/s**

Storgaten 88  
NO-3060 Svelvik  
Tel: +47 3329 7062  
info@exodraft.no  
www.exodraft.no

## **UK: Exodraft Ltd.**

24 Janes Meadow, Tarleton  
GB-Preston PR4 6ND  
Tel: +44 (0)1494 465 166  
Fax: +44 (0)1494 465 163  
info@exodraft.co.uk  
www.exodraft.co.uk

## **DE: Exodraft a/s**

Niederlassung Deutschland  
Industriestraße 14  
DE-55768 Hoppstädten-Weiersbach  
Tel: +49 6782 989 590  
Fax: +49 6782 989 5929  
info@exodraft.de  
www.exodraft.de

## **FR: Exodraft sas**

78, rue Paul Jozon  
FR-77300 Fontainebleau  
Tel: +33 (0)6 3852 3860  
info@exodraft.fr  
www.exodraft.fr

Your energy. Optimized.

The logo for Exodraft, featuring the word "exodraft" in a bold, lowercase sans-serif font. The letter "x" is stylized with a curved line that loops around the top and right sides of the letter.